

Drama *Aprile* Collezione 2026



 | CRIBEL®
industrie per l'arredamento

1.	<i>-Set tavoli e sedie</i>	6
	<i>-Tavoli in ceramica</i>	40
	<i>-Tavoli in legno</i>	64
	<i>-Tavoli in vetro</i>	77
	<i>-Tavoli contract</i>	78
2.	<i>-Poltrone e sedie</i>	84
	<i>-Sgabelli</i>	158
	<i>-Poltrone relax</i>	176
	<i>-Poltrone e divani</i>	186
	<i>-Sedute ufficio</i>	204
3.	<i>-Tavolini</i>	212
	<i>-Specchi</i>	232
	<i>-Consolle e madie</i>	236
	<i>-Piani e tavoli componibili</i>	238
4.	<i>-Outdoor</i>	262

Super Promo

tavoli allungabili

Dimensioni da chiuso: 160 x 90 x 75 cm

Dimensioni da aperto: 240 x 90 x 75 cm



Dimensioni da chiuso: 160 x 90 x 75 cm

Dimensioni da aperto: 240 x 90 x 75 cm



Dimensioni da chiuso: 180 x 90 x 75 cm

Dimensioni da aperto: 260 x 90 x 75 cm



Super Promo

tavoli Fissi

Dimensioni: 140*80*75



Dimensioni: 140*80*75



Dimensioni: DIA 120*75



SET
TAVOLI & SEDIE
Collection





Tortora:1500



SET XILON

Tavolo Estensibile con apertura laterale. Piano in Laminato e Allunghe in Alluminio, gambe ad incrocio in metallo.
Sedie realizzate interamente in polipropilene.

Dimensioni da chiuso: 180 x 90 x 75 cm

Dimensioni da aperto: 260 x 90 x 75 cm

SPESSORE PIANO 9 CM

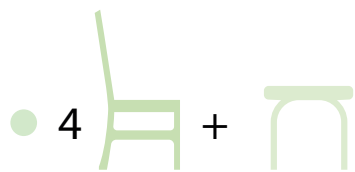

ALTRI COLORI DISPONIBILI:

Anracite:9506



Top rovere / nere :6732



Bianca:9490



Top rovere / bianche: 6749







Set tavoli allungabili e sedie

SET ANSON C/6 SEDIE

Tavolo Estensibile con apertura centrale. Piano in Laminato e Allunghe in Alluminio, gambe ad incrocio in metallo.

Sedia in velluto arricchita da decori sullo schienale e gambe in metallo.

Dimensioni da chiuso: 160 x 90 x 75 cm

Dimensioni da aperto: 240 x 90 x 75 cm

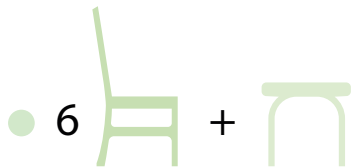

Senape:9153



ALTRI COLORI DISPONIBILI:

Blu:9160



Ruggine:9177



Top bianco / bianco : 6190







Set tavoli allungabili e sedie

SET VERMONT

Il piano del tavolo è realizzato in gres porcellanato effetto marmo, le gambe in metallo dalla forma geometrica a trapezio inclinato conferiscono al tavolo un aspetto moderno e imponente, garantendo al tempo stesso una stabilità ottimale. Sedia da pranzo, in velluto, gambe sottili in metallo.

Dimensioni da chiuso: 160 x 90 x 75 cm

Dimensioni da aperto: 240 x 90 x 75 cm

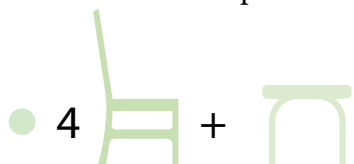

ALTRI COLORI DISPONIBILI:

Velluto porpora



velluto verde :6312



Tessuto petrolio :8684



Tessuto cenere:8639



Top bianco con venature /gambe bianche : 6701





Set tavoli fissi e sedie

SET POINT C/6 SEDIE

Tavolo Fisso con piano rettangolare con angoli leggermente stondati, realizzato in gres porcellanato

con venature grigie. La base è composta da gambe in metallo verniciato nero opaco, disposte in modo incrociato. La sedia è realizzata in velluto con chevron sullo schienale e gambe in metallo nere.

Dimensioni:

140*80*75

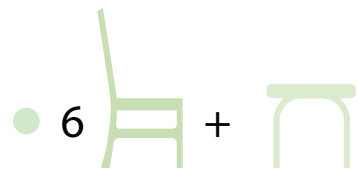

Top bianco con venature /gambe nere : 6398

Velluto blu:8644



SET TEXAS

Tavolo Fisso con piano rettangolare con angoli leggermente stondati, realizzato in gres porcellanato

con venature grigie. La base è composta da gambe in metallo verniciato nero opaco, disposte in modo incrociato. La sedia è realizzata in tessuto con uno schienale arrotondato, rombi sul retro dello schienale e gambe in metallo nere.

Dimensioni:

140*80*75

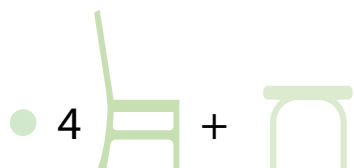

Top bianco con venature /gambe nere : 6398

Tessuto Verde:7227







Set tavoli fissi e sedie

SET ROYAL C/6 SEDIE

Il tavolo presenta un piano effetto marmo bianco con venature grigio chiaro, dall'aspetto raffinato e moderno. La struttura centrale in metallo nero con base a X incrociata conferisce forte carattere estetico, stabilità e un look architettonico deciso, perfetto per ambienti moderni e contract. Sedia da pranzo, in tessuto mozart o tessuto.

Dimensioni:

160*90*75

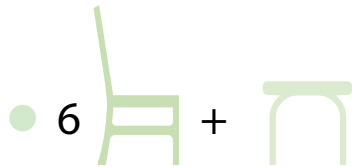

ALTRI COLORI DISPONIBILI:



**Mozart
tortora :5560**



**Mozart
grigio :1463**



**Mozart
fango :1432**



**Tessuto
grigio:6550**



**Tessuto
bordeaux:6031**



**Tessuto
verde:5751**

Top bianco con venature /gambe nere : 6763







Set tavoli fissi e sedie

SET FOUND

New!!!

Set pranzo dal design moderno ed elegante, composto da tavolo tonalità kashmir/beige, dagli angoli stondati e 4 gambe nere.

Le sedie sono rivestite in velluto, morbido al tatto e visivamente caldo, con schienale avvolgente e seduta confortevole. Anche le sedie poggiano su gambe in metallo nero

Dimensioni:

Tavolo: 140*80*76

Sedia: 44*52*85

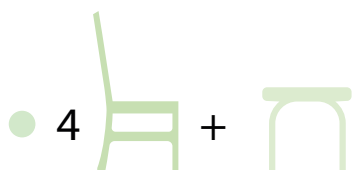

Piano Pandora /sedie senape:9320



ANGOLI STONDATI



Piano Pandora/sedie nere:9313



Piano Pandora/sedie verde smeraldo:9306





Ruggine: 6123



Set tavoli fissi e sedie

SET BRIGITTE

New!!!

Set composto da tavolo con piano tondo finitura pandora e gambe centrali incrociate bronzo.

4 poltrone imbottite con gambe in metallo nere.

Dimensioni:

DIA 120*75



ALTRI COLORI DISPONIBILI:

Genere: 6147



Verde: 7401

Top Pandora /gambe bronzo : 9740





Tortora:9139



Set tavoli fissi e sedie

SET ROYAL C/6 SEDIE

Il tavolo presenta un piano effetto marmo bianco con venature grigio chiaro, dall'aspetto raffinato e moderno. La struttura centrale in metallo nero con base a X incrociata conferisce forte carattere estetico.

La sedia è realizzata in velluto trapuntato e gambe in metallo nere.

Dimensioni:

160*90*75

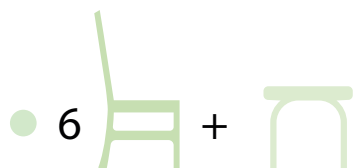

Fango:9146



Senape:9153



Petrolio:9160



Ruggine:9177



ALTRI COLORI DISPONIBILI:

Top bianco con venature /gambe nere : 6763



SET IGOR

Il tavolo presenta un piano effetto marmo bianco con venature grigio chiaro, dall'aspetto raffinato e moderno. La struttura centrale in metallo nero con base a X incrociata conferisce forte carattere estetico, stabilità e un look architettonico deciso, perfetto per ambienti moderni e contract.

La sedia è realizzata in velluto con uno schienale arrotondato, rombi sul retro dello schienale e gambe in metallo nere.

Dimensioni:

160*90*76



Top bianco con venature /gambe bianche : 9085

Cipria:8958





Set tavoli fissi e sedie

SET SINTRA

Tavolo Fisso con piano rettangolare con angoli leggermente stondati, realizzato in gres porcellanato con venature grigie. La base è composta da gambe in metallo verniciato nero opaco.

La sedia è realizzata in tessuto o velluto con uno schienale arrotondato e gambe in metallo nere.

Dimensioni:

140*90*76

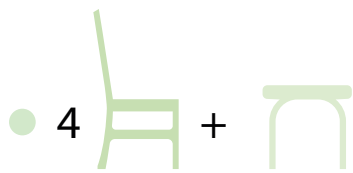

Top bianco con venature /gambe nere : 7647

Vinaccio/porpora



 Set tavoli fissi e sedie

SET ARBUSTO C/6 SEDIE

Tavolo rettangolare con base in metallo e **piano massello**, Il tavolo ha una forma rettangolare, classica ed elegante, che si adatta a diverse tipologie di ambienti. La base è costituita da una struttura in metallo, **spessore del tavolo 8 cm.**

La sedia è realizzata in velluto con un motivo chevron sullo schienale e gambe in metallo nere.

Dimensioni:
180*90*76

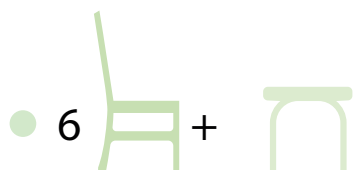

Velluto blu:8644

Piano massello/ gambe nere : 0725



 Set tavoli fissi e sedie

SET MARBLE *New!!!*

Tavolo Estensibile con Piano Effetto Rovere , Stile Nordico e Funzionalità Moderna. La struttura in metallo con gambe affusolate inclinate conferisce un tocco retrò e al contempo moderno, garantendo solidità e stabilità.
4 sedie realizzate interamente in metacrilato.

Dimensioni da chiuso: 160 x 90 x 75 cm

Dimensioni da aperto: 220 x 90 x 75 cm

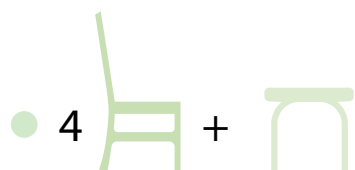

Top rovere /gambe nere :4404

Trasparente:9788





SET BENNY C/6 SEDIE

Set composto da un tavolo con struttura in metallo laccato e top in vetro e da 6 sedie in velluto trapuntato gambe nere.

Dimensioni tavolo: 140x80x75 (cm)

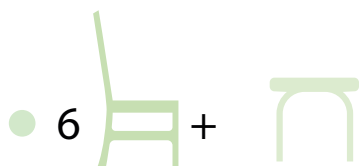

ALTRI COLORI DISPONIBILI:

Senape:9153



Petrolio:9160



Tortora:9139



Piano vetro / gambe nere:0985



Piano vetro / gambe bianche : 5850

Bianca:0992



 Set tavoli fissi e sedie

SET CHAPEAU

Questo tavolo presenta un design minimalista e moderno, perfetto per ambienti contemporanei e versatili. Struttura verniciata bianca, piano in vetro temperato bianco. Sedia impilabile realizzata interamente in polipropilene.

Dimensioni:
140*80*75 (cm)

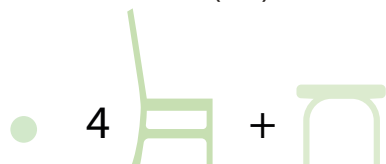

ALTRI COLORI DISPONIBILI:

Piano vetro / gambe silver:9078

Tortora:1012



Piano vetro / gambe nere:0985

Nera:1005



 Set tavoli fissi e sedie

SET BENNY C/6 SEDIE

Set composto da un tavolo con struttura in metallo laccato e top in vetro e da 6 sedie in polipropilene.

Dimensioni tavolo: 140x80x75 (cm)

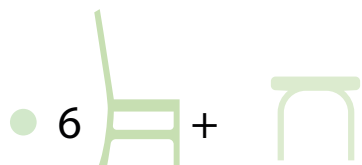

Salvia: 6169

Piano vetro / gambe nere: 0985





Set tavoli fissi e sedie

SET BELLA

Tavolo Fisso con piano rettangolare con angoli leggermente stondati, realizzato in gres porcellanato con venature grigie. La base è composta da gambe in metallo verniciato nero opaco.

Sedia impilabile realizzata interamente in polipropilene.

Dimensioni:

140*80*75 (cm)

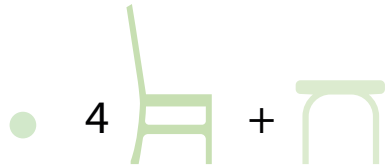

Antracite:8217

Top bianco con venature /gambe nere : 7647



 Set tavoli fissi e sedie

SET CORDOBA C/6 SEDIE

Il tavolo è un modello rettangolare dal design essenziale, con struttura in metallo verniciato bianco e linee pulite e squadrate. Il piano è in vetro temperato. Sedie in polipropilene bianche.

Dimensioni:
H75*D80*W140

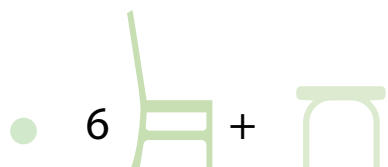

Bianco:5850

Bianco:9568





Set tavoli fissi e sedie

SET TETRIS

Tavolo autolivellante con struttura essenziale in metallo, con linee pulite e gambe perimetrali squadrate che garantiscono stabilità e un'estetica rigorosa. La finitura scura uniforme dona eleganza e solidità visiva, rendendolo adatto sia a contesti residenziali contemporanei sia a spazi professionali come ristoranti e sale pranzo. Sedie in polipropilene dal design minimal e funzionale, con schienale leggermente curvato e taglio orizzontale che alleggerisce la struttura e migliora l'ergonomia.

Dimensioni:
150*80*75 (cm)

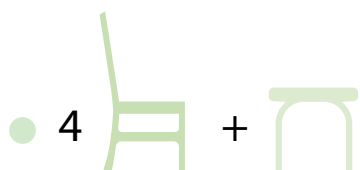

Antracite:1254

Antracite:8217



Bronzo:7098

Bronzo:1251





Set tavoli fissi e sedie

SET BENNY

Set composto da un tavolo con struttura in metallo laccato e top in vetro e da 4 sedie con struttura in metallo, seduta e schienale con imbottitura in poliuretano e rivestimento in similpelle.

Posti a sedere 4.

Dimensioni tavolo: 140x80x75 (cm)

Dimensioni sedie: 40.5x51x96

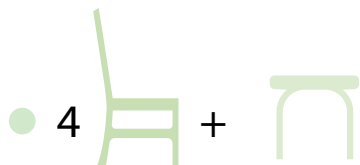

Cenere/
Bianco
9106





Set tavoli fissi e sedie

SET QUEEN C/6 SEDIE

Set composto da tavolo con gambe bianche e piano in vetro e 6 sedie ib ecopelle con gambe in alluminio bianche

Posti a sedere 6.

Dimensioni tavolo:

H75*D80*W140

Dimensioni sedie:

40*47*96 (cm)

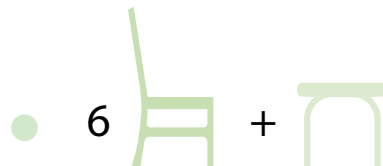

Piano vetro / gambe nere: 0985
nera / gambe nere: 5362

bianca/ gambe all:0022

Piano vetro / gambe silver : 9078



SET INDUSTRIAL

Set composto da tavolo quadrato e 4 sedie coordinate in metallo verniciato bianco.

Tavolo, con piano quadrato con bordo sottile e lineare, struttura in metallo con gambe leggermente inclinate e rinforzo centrale a croce.

Sedie: design monoscocca in metallo

Posti a sedere 4.

Dimensioni tavolo: 80*80*75

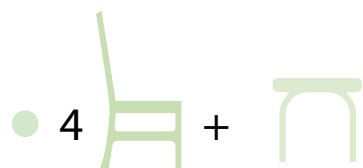

Bianco:7591

Bianco:6824



 Set tavoli fissi e sedie

SET SUNNY

Set composto da tavolo quadrato e quattro sedie monoscocca in polipropilene.

Il tavolo in metallo verniciato bianco presenta un piano pulito e lineare, sostenuto da una struttura centrale con gambe curve che garantiscono stabilità e leggerezza visiva.

Posti a sedere 4.

Dimensioni tavolo: 70*70*71

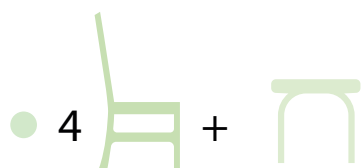

Bianco:6947

Bianco:0376



TAVOLI

Collection





Super Promo

tavoli allungabili

Dimensioni da chiuso: 160 x 90 x 75 cm

Dimensioni da aperto: 240 x 90 x 75 cm



Dimensioni da chiuso: 180 x 90 x 75 cm

Dimensioni da aperto: 260 x 90 x 75 cm



Dimensioni da chiuso: 160 x 90 x 75 cm

Dimensioni da aperto: 240 x 90 x 75 cm



Super Promo

tavoli Fissi

Dimensioni: 140*80*75



Dimensioni: 140*80*75



Dimensioni: DIA 120*75



ESTENDIBILE CON ALLUNGHE LATERALI



TOP PANDORA





Tavoli in ceramica

GEORGE *New!!!*

Tavolo da pranzo allungabile con allunghe esterne in Gres Porcellanato Effetto Marmo. La struttura in metallo verniciato si distingue per le gambe incrociate a design scultoreo, che donano stabilità e un'estetica ricercata.

posti a sedere: 6 da chiuso / fino a 10 da aperto.

Dimensioni da chiuso: 160 x 90 x 75 cm

Dimensioni da aperto: 240 x 90 x 75 cm

ALTRI COLORI DISPONIBILI:

Top bianco lucido /gambe bianche:9658



Top patagonia nero ven gold opaco /gambe nere:9641



Top Pandora /gambe bronzo:9627



 Tavoli in ceramica

PEGASO

Tavolo da pranzo allungabile con allunghe esterne in Gres Porcellanato Effetto Marmo. La struttura in metallo verniciato oro si distingue per le gambe incrociate a design scultoreo, che donano stabilità e un'estetica ricercata.

posti a sedere: 6 da chiuso / fino a 10 da aperto.

Dimensioni da chiuso: 160 x 90 x 75 cm

Dimensioni da aperto: 240 x 90 x 75 cm

ESTENDIBILE CON ALLUNGHE LATERALI

Top nero con venature oro /gambe Oro satinato:6727



© design registrato

FLORIDA

Il piano è realizzato in gres porcellanato opaco. Dotato di un sistema di estensione rotante, il tavolo si trasforma con un semplice gesto. Le gambe incrociate in metallo garantiscono stabilità e un impatto visivo di forte personalità.

Posti a sedere: 4-6 da chiuso, fino a 8 da aperto

Dimensioni da chiuso: 130 x 90 x 76 cm

Dimensioni da aperto: 190 x 90 x 76 cm

ESTENDIBILE CON SISTEMA DI ROTAZIONE



Top bianco con venature /gambe bianche: 6435



Top bianco con venature /gambe bianche : 6701





Tavoli in ceramica
VERMONT

Il piano del tavolo è realizzato in gres porcellanato effetto marmo, le gambe in metallo dalla forma geometrica a trapezio inclinato conferiscono al tavolo un aspetto moderno e imponente, garantendo al tempo stesso una stabilità ottimale.

Posti a sedere: 6 da chiuso / fino a 10 da aperto.

Dimensioni da chiuso: 160 x 90 x 75 cm

Dimensioni da aperto: 240 x 90 x 75 cm

ESTENDIBILE CON ALLUNGHE LATERALI



© design registrato



 Tavoli in ceramica

BRIGE *New!!!*

Tavolo allungabile con piano in Gres Porcellanato Effetto Marmo lucido, caratterizzato da un design contemporaneo ed essenziale. La struttura in metallo assicura solidità e stabilità, mentre le gambe inclinate e slanciate conferiscono leggerezza visiva e un segno moderno.

Il piano in ceramica, sottile e resistente, è impreziosito da delicate venature

Posti a sedere: 4-6 da chiuso, fino a 8 da aperto

Dimensioni da chiuso: 140 x 90 x 76 cm

Dimensioni da aperto: 210 x 90 x 76 cm

ALTRI COLORI DISPONIBILI:

ESTENDIBILE CON ALLUNGHE LATERALI

Top Pandora/gambe brozo: 9696



Top patagonia nero opaco con venat: 9689





ARTEMIDE *New!!!*

Tavolo dal design contemporaneo con piano dalla forma morbida e bordi arrotondati, caratterizzato da una superficie continua ed elegante. La struttura è composta da due basi centrali dalla geometria inclinata e scultorea, che garantiscono stabilità e forte presenza visiva senza appesantire l'insieme.

Posti a sedere: 4-6

Dimensioni da chiuso: 150 x 90 x H76 cm

Dimensioni da aperto: ø' 150 H76 cm

ESTENDIBILE CON ALLUNGHE LATERALI

ALTRI COLORI DISPONIBILI:

Top nero opaco: 9405



Top Pandora gambe bronzo: 9368







Tavoli in ceramica

SHUTTLE *New!!!*

Tavolo dal design contemporaneo con piano rotondo in Gres Porcellanato Effetto Marmo, meccanismo di rotazione integrato che consente di azionare l'allunga in modo fluido e intuitivo. La base centrale è dotata di un meccanismo robusto e ben integrato, da cui si diramano quattro gambe inclinate che garantiscono stabilità e slancio alla struttura.

Posti a sedere: 4-6 da chiuso, fino a 8 da aperto

Dimensioni da chiuso: 150 x 90 x H76 cm

Dimensioni da aperto: ø' 150 H76 cm

ESTENDIBILE CON SISTEMA DI ROTAZIONE

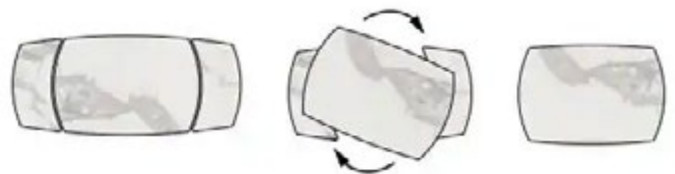

Top nero opaco: 9702



Top bianco lucido: 7002



TEXAS

Tavolo Fisso con Piano in Gres Porcellanato Effetto Marmo, La struttura in metallo, con gambe inclinate dal profilo sottile e dinamico, conferisce stabilità e leggerezza visiva al tavolo. Con dimensioni compatte, è perfetto per cucine, living moderni o angoli pranzo in ambienti open space.

Posti a sedere: 4.

Dimensioni: 140 x 80 x 75 cm

Top bianco con venature /gambe nere : 6398



AURA

Tavolo Fisso con piano rettangolare con angoli leggermente stondati, realizzato in gres porcellanato piano lucido con venature grigie. La base è composta da gambe in metallo verniciato nero opaco, disposte in modo incrociato e dinamico, creando un effetto scultoreo e di forte impatto estetico.

Stile contemporaneo e versatile, adatto sia a living moderni sia a zone pranzo eleganti e di design.

Aura saprà accogliere dalle 6-8 persone .

Posti a sedere:8.

Dimensioni:

180X85X75(cm)

Top patagonia lucido /gambe nere :5768



Top Pandora /gambe bronzo : 9740



 Tavoli in ceramica

ROYAL *New!!!*

Tavolo Fisso con Piano in Gres Porcellanato Effetto Marmo. La base in metallo con gambe incrociate asimmetriche conferisce al tavolo un forte carattere architettonico e una stabilità solida.
Royal saprà accogliere dalle 6-8 persone .

Dimensioni:
DIA 120*75

Top bianco con venature /gambe nere : 0041



ROYAL MIDI

Tavolo Fisso con Piano in Gres Porcellanato Effetto Marmo. La base in metallo con gambe incrociate asimmetriche conferisce al tavolo un forte carattere architettonico e una stabilità solida. Royal saprà accogliere 4 persone .

Dimensioni:
DIA 90X75

Top bianco con venature /gambe nere : 6756- 3pz



ROYAL

Tavolo Fisso con Piano in Gres Porcellanato Effetto Marmo. La base in metallo con gambe incrociate asimmetriche conferisce al tavolo un forte carattere architettonico e una stabilità solida. Royal saprà accogliere dalle 6-8 persone .

Posti a sedere: 6.

Dimensioni:
160X90X75(cm)

Top bianco con venature /gambe nere : 6763



IGOR

Tavolo rettangolare con base in metallo e piano in gres porcellanato effetto marmo bianco con finitura opaca,

La combinazione di bianco e nero crea un contrasto visivo elegante e contemporaneo.

Il piano bianco luminoso si sposa perfettamente con la base nera, creando un look sofisticato e versatile.

Posti a sedere: 6.

Dimensioni: 160 x 90 x 75 cm

Top bianco con venature /gambe bianche : 9085



 Tavoli in ceramica

SINTRA

Tavolo Fisso 4 gambe in metallo con Piano in Gres Porcellanato Effetto Marmo. Con dimensioni compatte, è perfetto per cucine, living moderni o angoli pranzo in ambienti open space.

Posti a sedere: 4.

Dimensioni: 140*80 x 75h

Top bianco con venature /gambe nere : 7647





Tavoli in laminato allungabili

SPIRIT *New!!!*

Tavolo estendibile da pranzo dal design contemporaneo, caratterizzato da un piano rotondo in nobilitato con bordo pieno e da una struttura centrale in metallo con gambe incrociate che garantiscono stabilità e solidità.

Posti a sedere: 8 da chiuso / fino a 10 da aperto.

Dimensioni da chiuso: ø120 H75 cm

Dimensioni da aperto: 160 x 120 x H75 cm

Top rovere /gambe nere :9764





 Tavoli in legno allungabili

IAGO

Un tavolo dal design deciso e contemporaneo, caratterizzato da un imponente piano in legno MASSELLO effetto naturale da 4 cm che dona calore e matericità all'ambiente. La base in metallo verniciato nero, composta da elementi geometrici intrecciati, conferisce stabilità e un forte impatto estetico, trasformando il tavolo in un vero elemento d'arredo. (Allunghe non integrate, da tenere apparte)
Posti a sedere: 6/8.

Dimensioni:
160(40+40)*90*76

Top rovere /gambe nere : 5720



© design registrato

Top rovere / gambe nere :6732



XILON

Tavolo Estensibile con Piano in Laminato e Allunghe in Alluminio – Stile Rustico Contemporaneo.

Le gambe incrociate in metallo creano una base solida e visivamente accattivante, che richiama lo stile industriale con un tocco di artigianalità rustica.

Posti a sedere: 8 da chiuso / fino a 10 da aperto.

Dimensioni da chiuso: 180 x 90 x 75 cm

Dimensioni da aperto: 260 x 90 x 75 cm

SPESSORE PIANO 9 CM

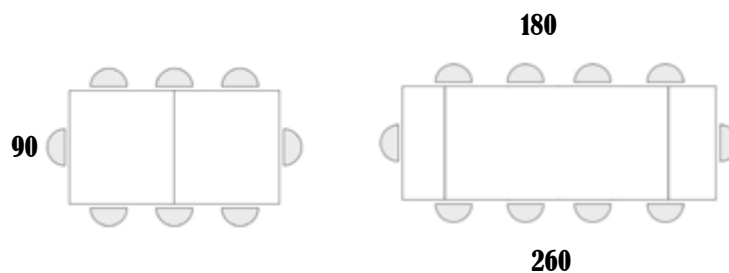

Top rovere / gambe bianche :6749





XILON MAXI

Tavolo estendibile con piano in laminato, **allunghe in alluminio** gambe incrociate in laminato, questo aggiunge un tocco di modernità al tuo arredamento. Xilon saprà accogliere dalle 10-16 persone (200-400X100X76 cm)

Posti a sedere: 8 da chiuso / fino a 14 da aperto.

Dimensioni da chiuso: 200 x 100 x 75 cm

Dimensioni da aperto: 400 x 100 x 75 cm

SPESSORE PIANO 9 CM

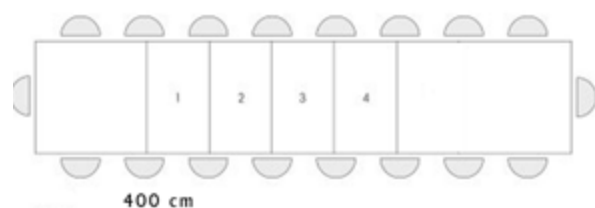

Top rovere / gambe bianche:6725





Top rovere / gambe bianche : 6062

ANSON

Tavolo allungabile con top in legno, **allunghe in alluminio** gambe centrali ad incrocio in metallo verniciato nero o bianche a polvere epossidica. Si allunga con facilità.

Posti a sedere: 6 da chiuso / fino a 8 da aperto.

Dimensioni da chiuso: 160 x 90 x 75 cm

Dimensioni da aperto: 240 x 90 x 75 cm

Top bianco / gambe bianche : 6190



MARBLE

Tavolo Estensibile con Piano Effetto Rovere , Stile Nordico e Funzionalità Moderna. La struttura in metallo con gambe affusolate inclinate conferisce un tocco retrò e al contempo moderno, garantendo solidità e stabilità.

Posti a sedere: 6 da chiuso / fino a 8 da aperto.

Dimensioni da chiuso: 160 x 90 x 75 cm

Dimensioni da aperto: 220 x 90 x 75 cm

Top rovere /gambe nere :4404



ARBUSTO

Tavolo rettangolare con base in metallo e **piano massello**, Il tavolo ha una forma rettangolare, classica ed elegante, che si adatta a diverse tipologie di ambienti. La base è costituita da una struttura in metallo, **spessore del tavolo 8 cm**.

Posti a sedere: 6.

Dimensioni:
180X90X76(cm)

Piano massello/ gambe nere : 0725



Tavoli in legno fissi

EDWIN

Funzionalità e stile si incontrano in questo tavolo da pranzo dalle linee pulite e contemporanee.

Il piano effetto rovere con raffinata lavorazione chevron dona un tocco decorativo distintivo, mentre le gambe in metallo nero assicurano stabilità e un contrasto moderno che valorizza qualsiasi ambiente.

Posti a sedere 4.

Dimensioni:
120*80*76 cm

Piano rovere / gambe nere : 5782



BENNY

Questo tavolo presenta un design minimalista e moderno. Piano in vetro temperato bianco, che dona luminosità e leggerezza visiva. Quattro gambe angolari a sezione quadrata, in metallo, che garantiscono solidità e stabilità

Posti a sedere 6.

Dimensioni:
140*90*75 (cm)

ALTRI COLORI DISPONIBILI:

Piano vetro / gambe bianche : 5850



Piano vetro / gambe silver : 9078



RING

Tavolo dal design moderno ed elegante, caratterizzato da una solida base conica in metallo nero lucido e da un piano rotondo in marmo, che unisce leggerezza visiva e raffinatezza.

La combinazione dei materiali crea un contrasto armonioso e contemporaneo, ideale per arredare zone living, spazi dining o ambienti contract con stile e personalità.

Dimensioni:
Ø60*H75 (cm)

Pietra effetto marmo\nero : 6284



SUNNY

Tavolo quadrato in metallo, con particolare gamba centrale. Questo tavolo si adatta perfettamente a diversi stili di ambienti.

Posti a sedere da 2 a 4 posti.

Dimensioni:
70*70*75 (cm)

Bianco:0376



 Tavoli contract
BARRY

Tavolo 80x80 cm dal design essenziale e contemporaneo.

Piano ovale con angoli arrotondati in rovere, dall'aspetto caldo e pulito. Struttura centrale a colonna singola in metallo verniciato bianco, che garantisce stabilità visiva e funzionale. Base ovale a terra, sempre in metallo bianco, sottile ma solida. Posti a sedere 4.

Dimensioni:
Ø80*H75 (cm)

Rovere bianco: 9799



FUTURE

Tavolo tondo realizzato interamente in polipropilene con fori sul piano, perfetto per ambienti esterni.

IL TAVOLO PRESENTA SUL PIANO DEI PICCOLI FORI.

Posti a sedere 3.

Dimensioni:
Ø60*H75 (cm)

Bianco : 6598





Verde : 1793

PIVOT

Tavolo in lamiera galvanizzata

Dimensioni:
60X60H75(cm)
80X80H75(cm) Bianco

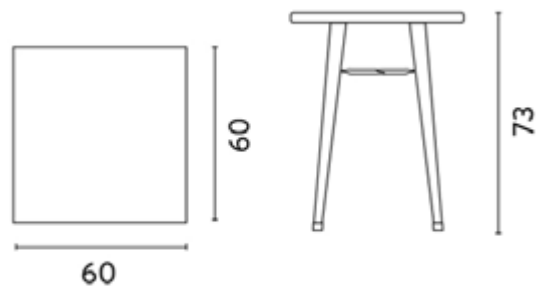

IMBOTTITI

Collection





Velluto ruggine ossidato:9030





Poltrone imbottite

TALLIN *New!!!*

Poltrona dal design contemporaneo con seduta imbottita e forme avvolgenti, pensata per garantire comfort ed eleganza. Lo schienale leggermente inclinato si integra con i braccioli creando una linea continua e armoniosa, mentre il cuscino della seduta aggiunge morbidezza e accoglienza, gambe in metallo nere.

x2

Velluto old green: 7579



Velluto lamè tabacco: 7333





Ruggine:9580



Poltrone imbottite

MONICA *New!!!*

Poltrona da pranzo dal design avvolgente e contemporaneo, caratterizzata da una struttura completamente imbottita con volumi pieni e continui. Lo schienale curvo integra i braccioli in un unico elemento fluido, offrendo comfort e sostegno. La seduta è ampia e accogliente, sostenuta da gambe integrate nella struttura che conferiscono solidità e un'estetica monolitica

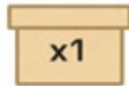

Dimensioni:
67*60*76

Verde:9573





Poltrone imbottite

ARTEMISIA

Poltrona da pranzo dalle linee sofisticate,
Il sedile e lo schienale sono rivestiti in un tessuto.
La struttura della sedia è in metallo nero.

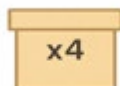

Dimensioni:
52*57*81 (cm)

blu / gambe nere: 7258



verde/ gambe nere: 7272



verde/ gambe nere: 7272



Tortora: 7265



ARTEMISIA GOLD

Poltrona da pranzo dalle linee sofisticate, Il sedile e lo schienale sono rivestiti in un tessuto. La struttura della sedia è in metallo dorato con una finitura lucida.



Dimensioni:
52*57*81 (cm)

ruggine/ gambe oro: 7319



Verde/ gambe oro: 7296



Tortora/ gambe oro: 7265





IRIDE *New!!!*

Poltrona imbottita caratterizzata da una seduta ampia e confortevole con schienale avvolgente leggermente inclinato. Il rivestimento in tessuto dalla trama materica dona profondità visiva e una sensazione tattile accogliente, mentre l'imbottitura equilibrata garantisce comfort senza appesantire il volume. La struttura è sostenuta da quattro gambe sottili in metallo verniciato nero, slanciate e leggere, che conferiscono stabilità e un aspetto moderno e raffinato.

Il "tessuto Aragon" non ha un'unica classificazione univoca, ma identifica tessuti di arredamento idrorepellenti, resistenti all'usura e dotati di tecnologie che impediscono l'assorbimento dei liquidi, rendendoli facili da pulire e ideali per divani e poltrone. La sua composizione esatta varia a seconda del produttore, ma è spesso caratterizzato da fili di contrasto e può includere finiture anti-macchia e resistenza alla luce.

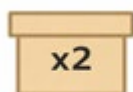

Dimensioni:
56*56.5*94

Verde:9191



Salmone:6497





Poltrone imbottite

LUNIA *New!!!*

Poltrona dal design moderno e avvolgente, caratterizzata da una seduta imbottita ampia e confortevole e da uno schienale continuo che integra i braccioli in un'unica forma morbida ed ergonomica.

La struttura è sostenuta da quattro gambe sottili in metallo, leggermente inclinate, che conferiscono leggerezza visiva e stabilità.

Il "tessuto Aragon" non ha un'unica classificazione univoca, ma identifica tessuti di arredamento idrorepellenti, resistenti all'usura e dotati di tecnologie che impediscono l'assorbimento dei liquidi, rendendoli facili da pulire e ideali per divani e poltrone. La sua composizione esatta varia a seconda del produttore, ma è spesso caratterizzato da fili di contrasto e può includere finiture anti-macchia e resistenza alla luce.

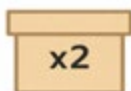

Dimensioni:
52*60*78

Grigio/ gambe nere: 9610



ruggine / gambe nere: 9597



Cenere/ gambe nere: 6147



Poltrone imbottite

BRIGITTE

Poltrona da pranzo dalle linee sofisticate, lo schienale e il sedile sono realizzati in resistente multistrato con imbottitura in poliuretano espanso per un maggiore comfort e rivestiti in piacevole tessuto di poliestere. Le gambe e il telaio sono realizzati in tubo di ferro



Dimensioni:
55*56*78 (cm)

Verde: 7401

Ruggine: 6123



© design registrato



Bouclè verde/ gambe nere: 0916



Poltrone imbottite

MEGAN

La poltrona linee pulite e forme arrotondate. Lo schienale alto e curvo, le gambe sottili in metallo nero contrastano con la morbidezza del rivestimento in tessuto bouclè.

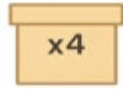

Dimensioni:
59*58*77.5 (cm)

Bouclè corda\gambe nere: 0930



© design registrato





Sedute imbottite

POINT

Sedia rivestita in velluto con schienale alto con motivo (chevron), gambe in metallo nere.

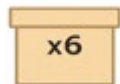

Dimensioni:
42X42XH89 HS49

Velluto blu:8644



 Sedute imbottite

KAREN

La sedia è realizzata in tessuto grigio con un dettaglio unico sullo schienale e gambe nere in metallo.



Dimensioni:
56X44X86.5 cm

Tessuto cenere:5799

Tessuto tortora:5775





Sedute imbottite

TAMARA

La sedia è realizzata in tessuto o velluto con uno schienale arrotondato, rombi sul retro dello schienale e gambe in metallo nere. Il design è elegante e raffinato, e la sedia è perfetta per un ambiente moderno e sofisticato. La sedia è ideale per la sala da pranzo, lo studio o la camera da letto.

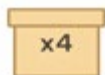

Dimensioni:
45*49*H85 HS 48 (cm)

Velluto cipria:8958



Tessuto verde inglese:6480



Tessuto Aragon blu:8972





Sedute imbottite

ARCA

Sedia in velluto, il sedile e lo schienale sono trapuntati con le gambe della sedia sono in metallo nero.

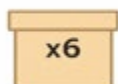

Dimensioni:
42X42XH89 HS49

Tortora:9139



Senape:9153



Ruggine:9177



Petrolio:9160





Tessuto bordeaux:6031

Tessuto grigio:6550

Tessuto verde:5751



Sedute imbottite

DEDIS

Sedia impilabile con alto schienale imbottito, struttura in metallo tubolare con imbottitura in poliuretano, interamente rivestita in tessuto mozart o tessuto.



Dimensioni:
*44*98 HS 46 (cm)

Mozart fango :1432



Mozart grigio:1463



Mozart tortora :5560



 Sedute imbottite

FRIDA

Lo schienale è composto da una serie di imbottiture verticali a sezione arrotondata che si aprono a ventaglio. È completamente rivestita in tessuto Aragon*. La seduta è ampia e imbottita, mentre le gambe, sottili e inclinate, sono in metallo nero opaco con terminali dorati.

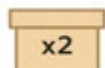

Dimensioni: 56X50X80

Verde: 7456



Grigio: 7432





Sedute imbottite

DANI

Le gambe sono rivestite in velluto sottili e slanciate la seduta che lo schienale sono imbottiti e rivestiti in velluto millerighe.



Dimensioni:
46*50*89 (cm)

Millerighe cenere: 5546



Millerighe tortora: 5539



Tessuto porpora\ vinaccio



velluto verde / gambe nere :6312



Sedute imbottite

NEW LENA TESSUTO

La sedia è realizzata in tessuto CANVAS che conferisce alla sedia un aspetto elegante e raffinato. La seduta è imbottita e presenta un motivo a rombi, che aggiunge un tocco di originalità al design. Le gambe sono sottili e slanciate, in metallo nero, che conferiscono alla sedia un aspetto leggero e moderno.

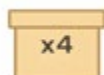

Dimensioni: 44*52*85

Tessuto cenere: 8639



Tessuto petrolio : 8684



Tessuto porpora vinaccio





velluto grigio/ gambe oro :5881



Sedute imbottite

NEW LENA GOLD

La sedia è realizzata in velluto, un tessuto morbido e lussuoso che conferisce alla sedia un aspetto elegante e raffinato. La seduta è imbottita e presenta un motivo a rombi, che aggiunge un tocco di originalità al design. Le gambe sono sottili e slanciate oro, che conferiscono alla sedia un aspetto elegante.

velluto nero/ gambe oro :8288

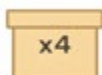

Dimensioni: 44*52*85

velluto fango / gambe oro :5874



velluto verde / gambe oro : 8057





Grigio

VIRGINIA

La sedia presenta una struttura elegante e contemporanea. Le gambe sono sottili e affusolate, realizzate in metallo nero, che conferiscono un aspetto leggero e slanciato. La seduta e lo schienale sono imbottiti e rivestiti in un tessuto Aragon*, resistente e facile da pulire, ideale per un uso quotidiano.

Il "tessuto Aragon" non ha un'unica classificazione univoca, ma identifica tessuti di arredamento idrorepellenti, resistenti all'usura e dotati di tecnologie che impediscono l'assorbimento dei liquidi, rendendoli facili da pulire e ideali per divani e poltrone. La sua composizione esatta varia a seconda del produttore, ma è spesso caratterizzato da fili di contrasto e può includere finiture anti-macchia e resistenza alla luce.

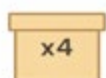

Dimensioni:
50*50*90 (cm)

verde:7463



Petrolio



Ruggine:9061





Sedute imbottite QUEEN

La sedia presenta una struttura metallica in alluminio dalle linee semplici e slanciate, Sia la seduta che lo schienale sono imbottiti e rivestiti in PU (tessuto non tessuto). Lo schienale alto e leggermente curvo offre un buon supporto alla schiena, mentre la seduta è ergonomica e confortevole.

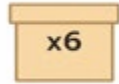

Dimensioni: 40*47*96 cm

nera / gambe nere: 5362



bianca/ gambe all:0022





PEPITA

Sedia con struttura in legno e seduta in bambù, lo schienale è caratterizzato da un design a "X", un elemento classico che richiama lo stile delle sedie da bistrot. Questa forma offre un buon supporto alla schiena.



Dimensioni:
48X52X89 (cm)

Bianco/bambù: 6673



Nero/bambù: 6680



NUOVA

Fly™

SEDIA

PIEGHEVOLE

SOLIDA

Funzionalità salvaspazio,
robustezza professionale,
comfort superiore.

TESSUTO
ARAGON

✓ Morbido
e Resistente



**STRUTTURA
IN METALLO**
Tubolare 25 mm

**PORTATA
FINO A**

**180
KG**

✓ **PIEGHEVOLE**

Spessore solo 5-10 cm

**STRUTTURA
IN METALLO**
Tubolare 25 mm

**PORTATA
FINO A
180 KG**

**SEDUTA
IMBOTTITA**

Sedie pieghevoli

FLY

New!!!

Una solida sedia pieghevole è un complemento d'arredo progettato per combinare la massima funzionalità salvaspazio con la robustezza e la stabilità di una sedia fissa. Queste sedie sono ideali sia per l'uso interno (pranzi, eventi) che esterno, garantendo un'elevata capacità di carico e una lunga durata nel tempo. Seduta e schienale in velluto, struttura Robusta: Il telaio è realizzato in acciaio verniciato a polvere o metallo (tubolare da 25 mm).Progettata per sostenere pesi notevoli.Seduta e Schienale rivestiti in velluto.Una volta piegata, la sedia occupa pochissimo spessore (circa 5-10 cm), facilitando lo stoccaggio dietro le porte, negli armadi o nel bagagliaio. I piedi sono dotati di capsule in plastica o gomma antiscivolo per proteggere i pavimenti.



Dimensioni:
45X40X79



Nera:9726

POLICARBONATO *Collection*









Sedie in polycarbonato

SPARTA *New!!!*

Sedia monoscocca in materiale plastico trasparente, dal design essenziale e contemporaneo. La struttura è definita da linee morbide e continue, con seduta leggermente sagomata e schienale curvo che assicura comfort e sostegno. Le quattro gambe, sottili e affusolate, si integrano armoniosamente nella scocca, mantenendo un'estetica leggera e visivamente pulita. La finitura completamente trasparente valorizza le forme e rende la sedia versatile, ideale per ambienti moderni sia residenziali che contract.



Dimensioni: 51X46X83



Trasparente:9788





Sedie in metacrilato

ZARA *New!!!*

Sedia in policarbonato trasparente dal forte richiamo barocco, caratterizzata da una silhouette elegante e scenografica.

Lo schienale è alto e sagomato, arricchito da decori ornamentali e motivi curvilinei che ne esaltano il gusto classico, reinterpretato in chiave contemporanea grazie alla totale trasparenza del materiale.

La seduta è ampia e leggermente sagomata, con profili morbidi che garantiscono comfort visivo e funzionale.

x4

Dimensioni:
53X55X99.5



Trasparente: 9801





Poltrone in metacrilato

ZARA *New!!!*

Sedia con braccioli in policarbonato trasparente, la struttura monoblocco è realizzata in materiale plastico trasparente ad alta resistenza, con finitura cristallina che valorizza le forme decorative. Lo schienale è sagomato e impreziosito da motivi barocchi in rilievo nella parte superiore, mentre la seduta è ampia, liscia e leggermente sagomata per garantire comfort. Le gambe sono slanciate e curvate, con dettagli decorativi integrati, conferendo eleganza e leggerezza visiva.

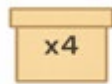

Dimensioni:
58X55X99.5



Trasparente:9795





Sedie in policarbonato

GAETA

Sedia trasparente in policarbonato, dal design iconico ed elegante.

La struttura è monoscocca, completamente trasparente, con schienale ovale morbido e avvolgente che richiama uno stile classico reinterpretato in chiave moderna.

La seduta è liscia, leggermente sagomata per garantire comfort, mentre le quattro gambe affusolate e leggermente arcuate conferiscono slancio e stabilità. La trasparenza del materiale valorizza le linee fluide e rende la sedia visivamente leggera, ideale per ambienti contemporanei, contract e residenziali.

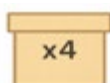

Dimensioni: 40*55*90



Trasparente:6688





Poltrone in metacrilato

ATENE *New!!!*

Sedia in policarbonato trasparente d'ispirazione classica, caratterizzata da un design elegante e senza tempo.

Lo schienale ovale, incorniciato da un delicato motivo a perline, conferisce raffinatezza e leggerezza visiva.

La seduta è ampia e leggermente arrotondata, con profili puliti che mantengono un'estetica armoniosa e funzionale.

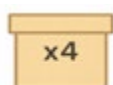

Dimensioni: 53X55X99.5



Trasparente:9825







Poltrone in metacrilato

ATENE *New!!!*

Poltrona monoblocco in policarbonato trasparente, dal design classico rivisitato in chiave contemporanea. Schienale ovale con cornice perimetrale lavorata a rilievo, braccioli curvi e integrati nella struttura che accompagnano la seduta in modo fluido. Seduta ampia e liscia, con spessori pieni che enfatizzano la solidità del materiale pur mantenendo un'estetica leggera.

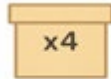

Dimensioni: 58*55*99.5



Trasparente:9818



POLIPROPILENE

Collection





Promo White

CORDOBA

Bianca:9568



* ordine minimo una pedana
monocolore (30 pz)

BRAGA

Bianca:1562



* ordine minimo una pedana
monocolore (12 pz)

ZANTE

Bianca:6909



* ordine minimo una pedana
monocolore (26 pz)

SIBARI

Bianca:6947



* ordine minimo una pedana
monocolore (26pz)

ELVIRA

Bianca:6527



* ordine minimo una pedana
monocolore (24\28 pz)

CHAPEAU

Bianca:0992



* ordine minimo una pedana
monocolore (36 pz)

CROSS

Bianca:9490



* ordine minimo una pe-
dana monocolore (22 pz)



Sedie in polipropilene

ARIEL

La sedia è realizzata interamente in polipropilene, un materiale leggero, resistente e facile da pulire. Lo schienale è caratterizzato da un motivo traforato che conferisce alla sedia leggerezza visiva e favorisce la traspirazione.

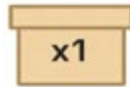

Dimensioni:
39.5X40X78 cm



Salvia:616

© design registrato



Sedie in polipropilene

CHAPEAU

Sedia realizzata interamente in polipropilene.

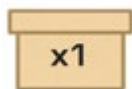

Dimensioni:
38*39*78 HS43 cm



Antracite:1005



Tortora:1012



Tortora:9667





Sedie in polipropilene

CORDOBA

Sedia in polipropilene, caratterizzata da un design minimalista e contemporaneo, caratterizzato da linee pulite e forme squadrate.

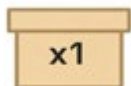

Dimensioni:
54*44*77 (cm)



Rosso mattone:9537



Carta da zucchero:9551



Senape:9544



Antracite:8217



Bronzo:7098





Sedie in polipropilene

BELLA

La sedia si presenta con una silhouette semplice ma decisa, un'icona di minimalismo funzionale. La seduta, ampia e leggermente concava, promette comfort senza fronzoli, invitando a una pausa di relax.

Lo schienale, di altezza media, è caratterizzato da una sottile fessura orizzontale, un dettaglio che aggiunge

un tocco di originalità senza compromettere la pulizia delle linee.

Realizzata in polipropilene perfetta per ambienti outdoor.

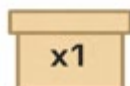

Dimensioni:
48 x 51.5 x 81



Verde:7135



Acero:7104



© design registrato





Sedie in polipropilene

ZANTE

Sedia in polipropilene, caratterizzata da un design minimalista e contemporaneo, caratterizzato da linee pulite e forme squadrate, perfetta per arredare ambienti esterni

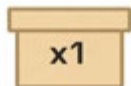

Dimensioni:
56X52X82 HS 46



Terracotta: 6886



Verde inglese: 6879





Ambra:6930



Sedie in polipropilene

SIBARI

Sedia in polipropilene, caratterizzata da un design minimalista e particolare, la seduta e lo schienale sono arricchiti da dei fori traspiranti.

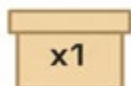

Dimensioni:
56X52X82 HS 46



Terracotta:6923



Verde inglese:6916





Bianca:6954



Poltrone in polipropilene

SIBARI

Poltrona in polipropilene, caratterizzata da un design particolare, caratterizzato da linee pulite e forme squadrate. la seduta e lo schienale sono arricchiti da dei fori traspiranti.

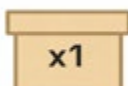

Dimensioni:
55*55*79 HS 46



Verde inglese: 7555



Mattone: 7548



Ambra: 6961





Verde inglese:6978



Sedie in polipropilene

ITACA

Sedia in polipropilene, caratterizzata da un design semplice e linee fluide, lo schienale e la seduta sono arricchiti da aperture verticali.

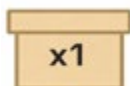

Dimensioni:
56X52X82 HS 46



Ambra:6992



Terracotta:6985





Ambra:7026



Poltrone in polipropilene

ITACA

Poltrona in polipropilene, caratterizzata da un design semplice e linee fluide, lo schienale e la seduta sono arricchiti da aperture verticali.

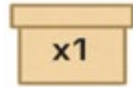

Dimensioni:
55*57*81 HS45



Mattone: 7029



Verde inglese: 7012





Sedie in polipropilene

CROSS

Sedia in polipropilene con design classico e senza tempo, caratterizzato da linee semplici e pulite.

La struttura è composta da una seduta e uno schienale in polipropilene, con un motivo a croce che conferisce alla sedia un tocco di eleganza.

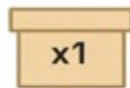

Dimensioni:
90x43x43 (cm)



Tortora:1500



Azzurra:8064



Nera:9506





Sedie in polipropilene

YARD

Sedia in resina dalle linee pulite e minimal garantisce leggerezza e maneggevolezza.

Dimensioni:

53.5*60*H89 HS46 cm



Antracite: 6669





Tortora:1579

Nero:9940



Sedie in polipropilene

BRAGA

La sedia è realizzata interamente in polipropilene , un materiale resistente agli agenti atmosferici e facile da pulire.

La seduta e lo schienale sono formati da un intreccio che crea un motivo a rete, conferendo alla sedia un aspetto leggero e arioso. La sedia è impilabile, il che la rende pratica da riporre quando non è in uso.

Braga è adatta sia per uso domestico che commerciale.

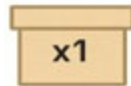

Dimensioni:
60x50x82(cm)



Mattone:9575



Verde oliva:1470



Carta da zucchero:6558



Senape:1586



© design registrato

 Sedie in metallo

INDUSTRIAL

Sedie stile industriale vintage realizzate in metallo verniciato a polvere, robuste e resistenti.

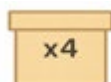

Dimensioni: 40*50*85 cm



Bianca:6824



COVER SEDIE

Cover per pila di quattro sedie – misura 66 x 66 x h. 120 cm – poliestere impermeabile ed extra resistente – con prese d'aria



Grigio: ART01546



Poltrone in metallo

RIMINI

La sedia è un modello bistrot contemporaneo con struttura snella in metallo e seduta + schienale intrecciati.

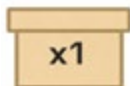

Dimensioni:
56*59*78 HS45



Verde:1552



Antracite :6215



Corda\ antracite:1681



Corda\ bianco:1680





Bianca: 7142

Poltrone in polipropilene

MAIORCA

La struttura è composta da gambe e braccioli in polipropilene, che conferiscono alla sedia un aspetto solido e resistente. Le linee sono semplici e pulite, con forme curve che la rendono ergonomica e confortevole.

Lo schienale è la caratteristica distintiva di questa sedia. È realizzato con un intreccio di corde **NATURALI**, spesso di colore naturale o chiaro, che crea un effetto visivo caldo e accogliente.

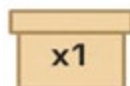

Dimensioni: 56x55x78 cm



Antracite: 7159



© design registrato

SGABELLI

Collection







Tortora:6154



Sgabelli imbottiti

BRIGITTE

Linee moderne e accoglienti si fondono nello sgabello imbottito, rivestito in tessuto perfetto per ambienti cucina o zona snack dal gusto contemporaneo. La struttura slanciata in metallo verniciato nero opaco garantisce stabilità e leggerezza visiva, mentre il poggiatesta integrato assicura comfort anche durante le sedute prolungate.

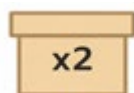

Dimensioni:

50x50x110 **HS 75**

50x50x110 **HS 65**

Verde:7500



Cenere:6178



Ruggine:6161



 Sgabelli imbottiti

NEW TAMARA

Lo sgabello è realizzato in tessuto con uno schienale arrotondato e gambe in metallo nere. Il design è elegante e raffinato, perfetto per un ambiente moderno e sofisticato.

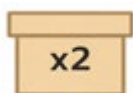

Dimensioni:

42x40x108 **HS 75**

42x40x108 **HS 65**



Tessuto verde

NEW LENA

La seduta è imbottita e rivestita in tessuto con un motivo a rombi sullo schienale, gambe in metallo nere.

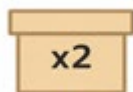

Dimensioni:

44*53*112 HS 75 cm

44*53*112 HS 65 cm

Cenere:8813



Tortora:8806



Corda:8790



Fango:8868



 Sgabelli imbottiti

ARTEMISIA GOLD

Lo sgabello è realizzato in tessuto con uno schienale arrotondato e gambe cromate oro . Il design è elegante e raffinato, perfetto per un ambiente moderno e sofisticato.

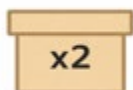

Dimensioni:

52*57*81 **HS 75**

52*57*81 **HS 65**



Ruggine:9054



Sgabelli imbottiti

ARTEMISIA

Lo sgabello è realizzato in tessuto con uno schienale arrotondato e gambe in metallo nere. Il design è elegante e raffinato, perfetto per un ambiente moderno e sofisticato.

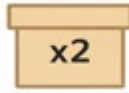

Dimensioni:

52*57*81 **HS 75**

52*57*81 **HS 65**

Verde:9016



Blu:9009



Tortora:9023



Ruggine:9047







Sgabelli imbottiti

MEGAN

Lo sgabello è realizzato in tessuto bouclè , un materiale morbido e lussuoso che conferisce allo sgabello un aspetto elegante e raffinato. Lo schienale è curvo e avvolgente, mentre la seduta è ampia e confortevole. Le gambe sono sottili e slanciate, in metallo nero, che conferiscono allo sgabello un aspetto leggero e moderno.

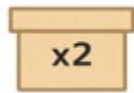

Dimensioni:

53x45x86 HS: 75

53x45x86HS: 65

Verde:0961





Bronzo: 7067



Sgabelli Polipropilene

BELLA

Sgabello realizzato interamente in polipropilene.



Dimensioni:
53*54*102 HS75



Tortora: 7050



Bianco: 7074



Antracite: 8224



© design registrato



Bianco:9926

CROSS

Sgabello in polipropilene, schienale a x seduta ampia e sagomata.

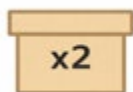

Dimensioni:
48*49*H102 HS74



Antracite:9919



Tortora:8071



BRAGA

Sgabello realizzato interamente in polipropilene, La seduta e lo schienale sono integrati in un unico pezzo formando una superficie traforata.

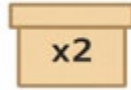

Dimensioni:
45*51*H106 HS75(cm)



Bianco:9964



ZANTE

Sgabello realizzato interamente in polipropilene, La seduta e lo schienale sono integrati in un unico pezzo

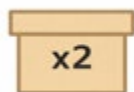

Dimensioni:
49*55*104 HS 75



Ambra:6855





 Sgabelli in metallo

INDUSTRIAL

Sgabello stile industriale vintage realizzato in metallo verniciato a polvere, dalla a una forma semplice e lineare , Il design neutro e le dimensioni standard lo rendono adatto a diversi spazi e stili d'arredo.

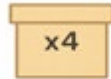

Dimensioni: 30*30*76 cm

Bianco:6848



POLTRONE RELAX

Collection







ARLETTE A IGNIFUGA

Caratteristiche principali:

Poltrona relax con meccanismo reclinabile manuale tramite leva, la poltrona presenta un design elegante e senza tempo, caratterizzato da linee morbide e dettagli curati. Il rivestimento è in tessuto Mozart ignifugo. Lo schienale è alto e avvolgente, con una forma leggermente arrotondata che ricorda le poltrone classiche. Inoltre la poltrona è dotata di alette laterali che offrono un ottimo sostegno per la testa e il collo.

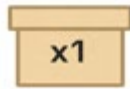

Dimensioni:

74*74*109

Mozart grigia cemento:1845







Poltrone relax

GIUDITTA A

Caratteristiche principali:

- Meccanismo: reclinabile manuale con leva laterale
- Rivestimento: tessuto di alta qualità
- Schienale alto e curvo per supporto ottimale
- Seduta imbottita, ampia e confortevole
- Braccioli imbottiti dalla forma arrotondata

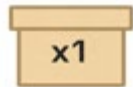

Dimensioni:

80*88*102

Safari:6369





CARLOTTA A

Caratteristiche principali:

- Meccanismo: reclinabile manuale con leva laterale
- Rivestimento: tessuto di alta qualità
- Schienale alto e curvo per supporto ottimale
- Seduta imbottita, ampia e confortevole
- Braccioli imbottiti dalla forma arrotondata

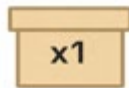

Dimensioni:

70*87*104



Safari:8943



CARLOTTA D LIFT

Caratteristiche principali:

- Meccanismo: elettrico recliner + alzapersona
- Comandi: pulsantiera laterale intuitiva
- Funzione USB: ricarica dispositivi mobili integrata
- Comfort: imbottitura ergonomica e schienale alto

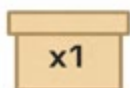

Dimensioni:

68*87*104



Corda: 6338

POLTRONE & DIVANI *Collection*





Super Promo

Poltrone

tris €310

tris €249



SET CHALEN 3+2 POSTI

Set divano 3+2 posti con 4 recliner totali manuale è pensato per trasformare ogni momento di relax in un'esperienza unica. Disponibile in due tonalità: taupe e verde britannico. Realizzati in tessuto Benidorm Cat D, un tessuto pesante e robusto composto da cotone e poliestere, con trama grossolana e resistente.

Taupe



Verde
Britannico

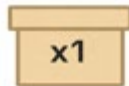

Dimensioni:
189*92*100+138*92*100



Tessuto Taupe:9276



Tessuto britannico:9283



Tessuto britannico:9511



SET CHALEN 3+2 POSTI

Set divano 3+2 posti con 4 recliner totali elettrico con pulsantiera. Pensato per trasformare ogni momento di relax in un'esperienza unica. Disponibile in due tonalità: taupe e verde britannico. Realizzati in tessuto Benidorm Cat D, un tessuto pesante e robusto composto da cotone e poliestere, con trama grossolana e resistente.

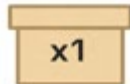

Dimensioni:
189*92*100+138*92*100



Taupe



Verde
Britannico



Tessuto Taupe:9504





MARILYN

La poltrona presenta un design che unisce elementi classici e moderni.

Il rivestimento è in tessuto a pied de poule.

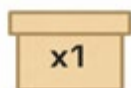

Dimensioni:
78*86*H84

black and white:9771



© design registrato



MILO

Poltrona in velluto dal design compatto e avvolgente, caratterizzata da una silhouette morbida e continua che crea un effetto accogliente ed elegante. Lo schienale curvo e i braccioli integrati formano un unico volume armonioso, studiato per offrire comfort e sostegno ottimale.

La seduta imbottita garantisce una piacevole sensazione di relax, mentre le linee pulite e la cura dei dettagli sartoriali valorizzano l'estetica contemporanea del prodotto.

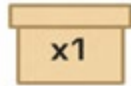

Dimensioni:
68x64x73 cm



Velluto Ruggine:9559





TEDDY

La poltrona presenta un design unico e caratteristico, con forme morbide e arrotondate che invitano al relax. Il contrasto tra la struttura in metallo nero e il rivestimento morbido in tessuto bouclè crea un effetto visivo interessante e accattivante.

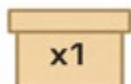

Dimensioni: 85*83*71.5 cm

Grigio: 7948



© design registrato

Tortora:6642



NIKOS

Il rivestimento è in tessuto moztart **SFODERABILE**, la seduta e lo schienale sono imbottiti e presentano delle cuciture verticali, gambe in metallo

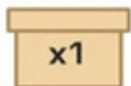

Dimensioni:
71X77X83 cm

Rame:6635





FRIDA

La poltrona presenta un design sofisticato e accogliente, caratterizzato da linee morbide e sinuose che richiamano la forma di un fiore. Il rivestimento in velluto o tessuto bouclè che conferisce alla poltrona un aspetto lussuoso e contemporaneo. La struttura della poltrona è probabilmente in metallo cromato oro, rivestita con imbottitura in schiuma per garantire un comfort ottimale.

*Completa di cuscino

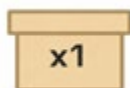

Dimensioni:
82*79*H79

Senape:0084



Ruggine:0091



Bouclè Panna: 8004



Nero:0060





Bouclè Panna:8134



DIVANO FRIDA

Elegante e unico, il divano è l'eyecatcher ottimo per living, soggiorni, stanze da letto o locali.

Il suo design rievoca i divani dell'art nouveau, il rivestimento in bouclè o è messo in risalto dal colore ottone delle gambe, piccole, ma resistenti, sottili e discrete.

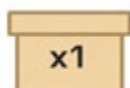

Dimensioni:
136*79*79

Senape:0213



Ruggine:0206



**WORK
HARD**
& BE NICE
TO PEOPLE

UFFICIO

Collection





Super Promo

Sedie d'ufficio

Bianco:7931



Bianco:7948



MITO PRESIDENZ

La poltrona presenta una struttura in metallo cromato, Lo schienale alto è caratterizzato da un design avvolgente e diviso in più cuscini imbottiti in PU rigenerato tessuto non tessuto.

La seduta è ampia e imbottita, garantendo un comfort prolungato anche durante lunghe ore di lavoro.

La base è dotata di cinque ruote per una facile mobilità.

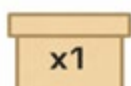

Dimensioni:
07.5-117.5*61*56 (cm)

*Super
Promo*

Bianco:7955



Nero:8192



Grigio:4930



Tortora:4947







Poltrona da cameretta

SAMIRA

La Poltrona presenta una struttura ergonomica e avvolgente, realizzata in polipropilene.

Lo schienale è caratterizzato da un design particolare, con fori a forma di impronte di zampe che conferiscono un tocco giocoso e originale.

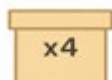

Dimensioni:
49*57*83/95 (cm)



Grigio:6671



Ambra:6640



Tortora:6664



Bianca:6657



Blu:8088



Petrolio:8095



© design registrato

GAMING OMEGA

Lo schienale alto è caratterizzato da un design avvolgente e sportivo, spesso con cuscini lombari e poggiatesta integrati per offrire un ottimo supporto alla zona lombare e cervicale, il rivestimento è in PU tessuto non tessuto. Inoltre la sedia è dotata di un poggiatesta ed è possibile reclinare lo schienale o regolarlo in altezza.

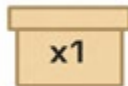

Dimensioni:
61x51x120/130 (cm)

Rosso:6606

*Super
Promo*





Poltrone da ufficio

GAMING ALFA

Lo schienale alto è caratterizzato da un design avvolgente e sportivo, spesso con cuscini lombari e

poggiatesta integrati per offrire un ottimo supporto alla zona lombare e cervicale, il rivestimento è in PU

tessuto non tessuto. Inoltre è possibile reclinare lo schienale o regolarlo in altezza.

Dimensioni:

65*62*105/110 (cm)

Blu:5447



Nero:5416



Bianca:5454



TAVOLINI

Collection







Bianco:8187

SET ALTEA

Entrambi i tavolini sono realizzati interamente in metallo, con una finitura nera opaca che conferisce un aspetto elegante e moderno. La forma è caratterizzata da linee semplici e geometriche. Entrambi i tavolini hanno un piano superiore rotondo e una base a forma di tronco di cono rovesciato. La differenza tra i due tavolini sta nelle dimensioni, con un tavolo più grande e uno più piccolo, creando un effetto visivo interessante.

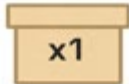

Dimensioni:

DIA 70*40+DIA 50*48 cm (nero)

DIA 50X48 CM + 70X38 CM (bianco)



Nero:6253



SOLEIL

Il tavolino presenta una combinazione di materiali che conferiscono un aspetto elegante e contemporaneo:

Piano: Realizzato in marmo bianco, un materiale naturale caratterizzato da venature. La forma è rotonda, conferendo al tavolino un aspetto leggero ed equilibrato.

Base: Realizzata in metallo, verniciato di nero, per creare un contrasto visivo con il bianco del marmo. La base è composta da due parti: una parte superiore a forma di vaso o colonna, che sostiene il piano, e una base più ampia a forma di cono, che garantisce la stabilità.

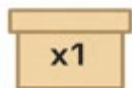

Dimensioni:
DIA50*63



Struttura nera/piano bianco con venature: 6260



RENEE'

Il tavolino presenta una combinazione di materiali:
Piano e ripiano inferiore: Realizzati in vetro temperato trasparente, offrono un aspetto elegante e moderno, oltre a una facile pulizia.

Gambe: Realizzate in legno laccato bianco o cemento, conferiscono un tocco di calore e contrasto al vetro. Le gambe sono spesso dotate di piedini in metallo cromato per una maggiore stabilità e un tocco di raffinatezza.

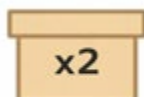

Dimensioni:
100*60*45 cm



Bianco:1524



Cemento:6109

VERSUS

Il tavolino nella foto è un complemento d'arredo dal design moderno e minimalista, realizzato completamente in vetro curvato trasparente. La sua forma a "C" rovesciata lo rende estremamente funzionale: può essere utilizzato come tavolino da salotto, piano d'appoggio laterale per un divano o una poltrona, oppure anche come comodino.

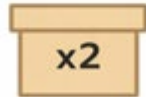

Dimensioni:
120*60*30

vetro:9210





CORINNE

Tavolino da salotto interamente realizzato in vetro curvato, dallo spessore robusto e resistente. La sua forma originale a profilo ondulato crea un design moderno e dinamico, pur mantenendo linee semplici ed eleganti. La trasparenza del vetro dona leggerezza visiva, rendendolo ideale per ambienti contemporanei e minimalisti, senza appesantire lo spazio. Perfetto come coffee table, si adatta facilmente a diversi stili d'arredo grazie alla sua versatilità e raffinatezza.

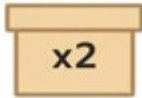

Dimensioni:
120*60*38 (cm)

vetro:9227



 Tavolini
HALL

Il tavolino nella foto è un complemento d'arredo dal design moderno e minimalista, realizzato completamente in vetro curvato trasparente. La sua forma a "C" rovesciata lo rende estremamente funzionale: può essere utilizzato come tavolino da salotto, piano d'appoggio laterale per un divano o una poltrona, oppure anche come comodino.

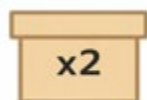

Dimensioni: 40*40*60

vetro:9197



BELLY

Il tavolino è realizzato principalmente in metallo. Il piano superiore è in metallo con una finitura dorata che gli conferisce un aspetto elegante e luminoso. La struttura portante, ovvero le gambe, è anch'essa in metallo, ma con una finitura nera che crea un interessante contrasto con il piano.

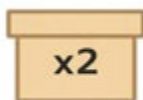

Dimensioni:
H48,5 Ø40 cm

Oro:2189





SET TAVOLINI CIRCLE

I tavolini presentano una combinazione di materiali:

Piano: Realizzato laminato, con una finitura rovere che conferisce un aspetto naturale e caldo.

Struttura: Realizzata in metallo laccato nero, con un design traforato che crea un motivo decorativo.

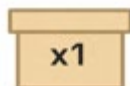

Dimensioni:

BIG: 40X45 SMALL 33.5X40 cm

Nero:6710





LESHA

Tavolino realizzato in metallo, il piano superiore è di colore bianco legno decapato, mentre il corpo presenta una base chiara con un motivo dorato e rosa. Il motivo è traforato e simula una lavorazione artigianale in stile orientale o arabeggiante.

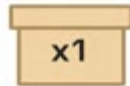

Dimensioni:
DIA:40X44



Rosaloro:2165



SET TAVOLINI HEXAGON

Questo set di tavolini presenta una combinazione interessante di materiali:

Piano: Realizzato in laminato dalla forma esagonale. Struttura: Realizzata in metallo verniciato di nero. La struttura è composta da linee geometriche che si intersecano creando una forma tridimensionale.

I tavolini sono dimensioni diverse, creando un effetto visivo dinamico.

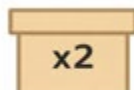

Dimensioni:

BIG: H41,5*P39*L45 SMALL: H39*P35*L40,5 cm



Rovere:2080

Tavolini
MODAS

tavolino in metallo

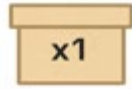

Dimensioni: 60x60 h30

Nero:9577



Grigio:9560



Bianco:9553



Tavolini
MODAS

tavolino in metallo

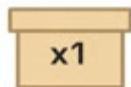

Dimensioni: 80x60 h30

Nero:9607



Grigio:9591



SPECCHIERE *Collection*





MAGIK 120

Lo specchio ha una forma rettangolare allungata, ma con contorni irregolari e sinuosi che conferiscono alla cornice un aspetto scultoreo.

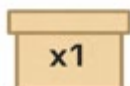

Dimensioni:
121x2,5x90 (cm)

Grigio:1045



Oro/Nero:1021



MAGIK 90

Lo specchio ha una forma rettangolare allungata, ma con contorni irregolari e sinuosi che conferiscono alla cornice un aspetto scultoreo.

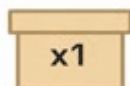

Dimensioni:
1x2,5x60 (cm)



Oro/Nero:0994



Grigio:1007



CONSOLLE *Collection*

TEKA

Elemento particolare è la struttura in metallo dorato, seppur dal design lineare presenta una decorazione, adiacente al piano in vetro temperato, che la rende unica e un eyecatcher ideale per arredare il proprio living, o sala da pranzo o salotto,

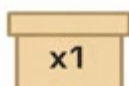

Dimensioni:
120*40*H75 (cm)



Oro | Vetro: 0222

*TAVOLI
CONTRACT
Collection*





 Piani componibili

DIAMOND

Piano in microceramica da 12 mm

-80x80 (cm)

-70x70 (cm)

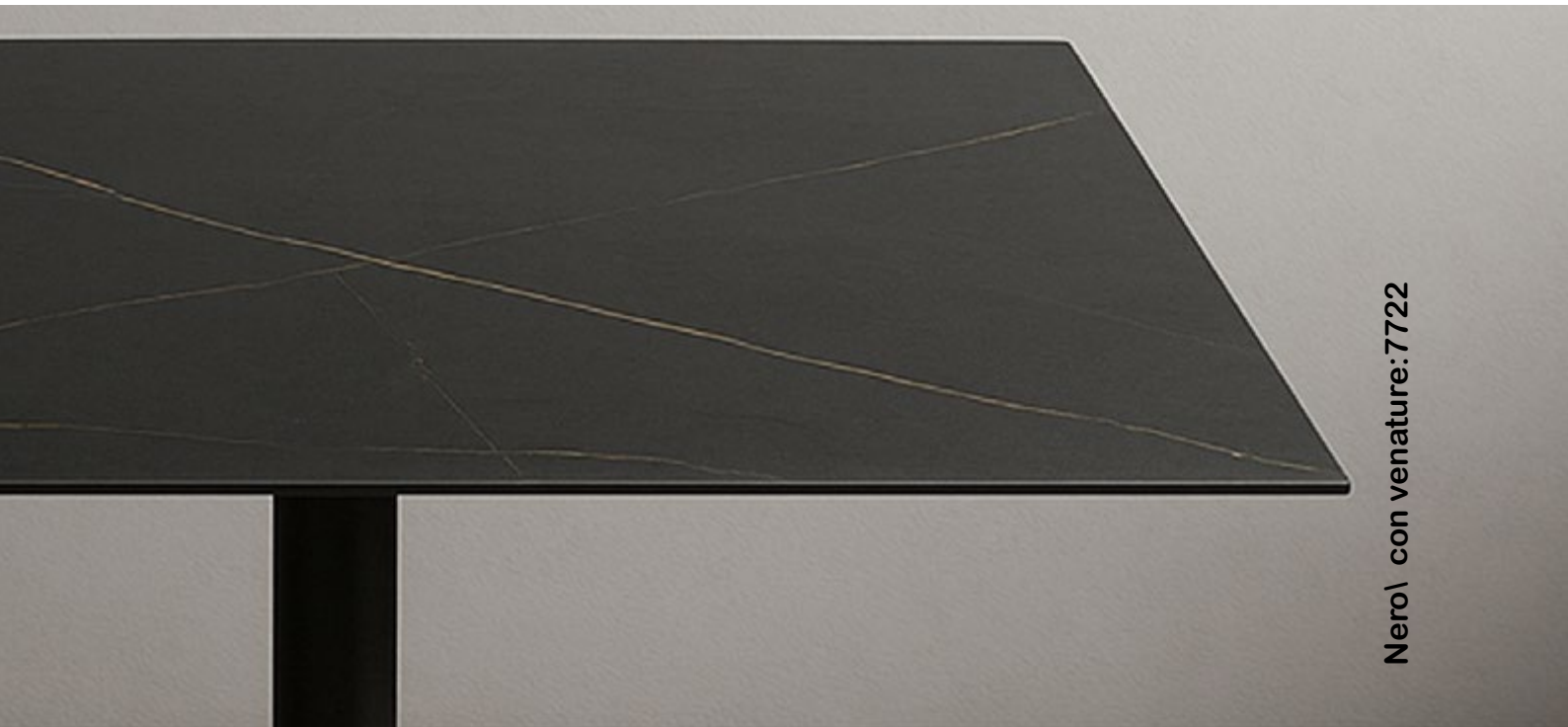

Nero\ con venature:7722

Grigio\ venature bianche:6444

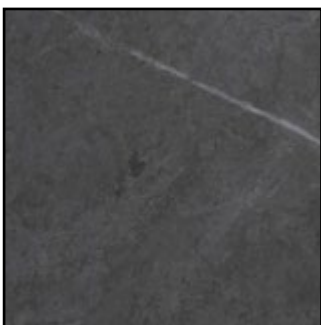

Calacatta beige:7807

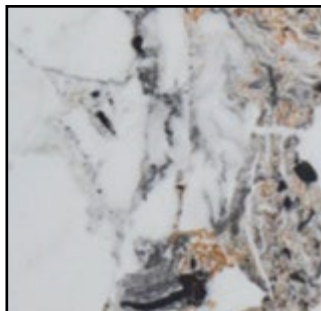

Bianco\ venature grigie:6437



 Piani componibili

DIAMOND

Piano in microceramica da 12 mm tondo.

-ø60 (cm)

-ø65 (cm)

-ø70 (cm)

-ø75 (cm)

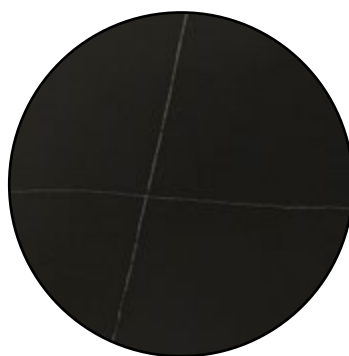
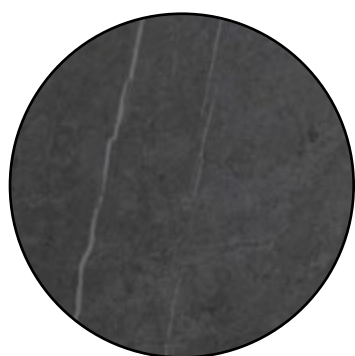

DIAMOND BORDO ORO

Piano in microceramica con bordo oro DA 30 mm
-70x70 (cm)
-80x80 (cm)



Nero\ con venature:6475



Calacatta beige:6475

Piani componibili PIANO HPL

Piano in hpl, dotato di superfici resistenti, impermeabili e igieniche. La maggior parte delle macchie si rimuove con acqua e detersivi domestici non aggressivi.

Per una cura ottimale si consiglia una spugna morbida con sapone neutro o pulitori specifici per HPL.

-70x70 (cm)

-80x80 (cm)

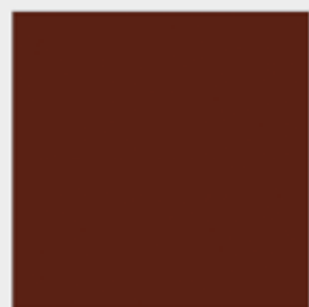

LAGOS

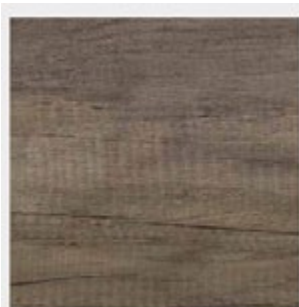

MAHEN

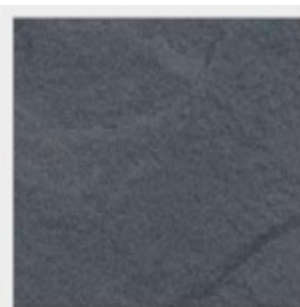

CEMENTO

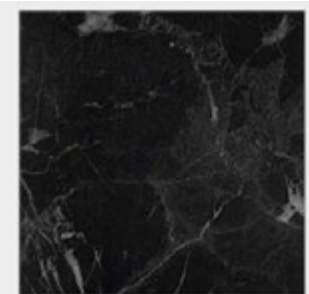

TAHE'



PIETRA



ARDESIA



BALE'

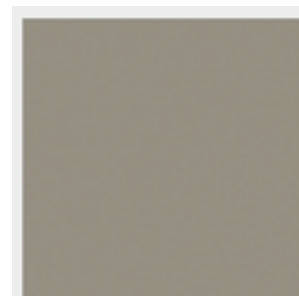

TAUPE



Sistema di
fissaggio
universale

PIANO LAMINATO

-80x80 (cm)

-70x70 (cm)

-90x90 (cm)



PIANO LAMINATO BORDO ORO

- 80x80 (cm)
- 70x70 (cm)
- 90x90 (cm)



CANNERO



ISPRA



VERBANIA



CANNOBIO



PIANO MANGO

Legno Mango 9483



-80x80 (cm)

PIANO LEGNO

Legno naturale: 9292



-80x80 (cm)
- 70X70 (cm)

PIANO TEAK

-80x80 (cm)



Teak:8033



Basi componibili

DIAMOND SNACK

Base per tavolo componibile

Dimensioni: DIA62 h108



Nero: 7753

Bianco: 7821



H 108



Basi componibili

MOANA



Nero: 7760

Bianco: 7777

Base in acciaio laccata nera o bianca.

Dimensioni: DIA50 H 75 (cm)

BASE ABBY



Bianco: 9711

Base per tavolo componibile

Dimensioni: 49X49XH75 (cm)

BASE DIANA



Bianca: 7180

Base per tavolo in ghisa 4 gambe a raggiera

Dimensioni: 56xh75 (cm)

BASE DALAN



Nero/oro: 7203

Base in ghisa nera con dettagli oro.

Dimensioni: 40X H75 (cm)

BASE PIRAMIDE

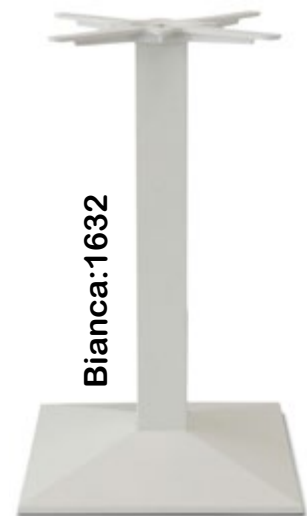

Bianca: 1632

Base per tavolo componibile in ghisa.

Dimensioni: 43X43xH 72



BASE MARIO



Bianca:0659

Base per tavolo componibile

Dimensioni: 61x61x 75 (cm)

BASE GHISA

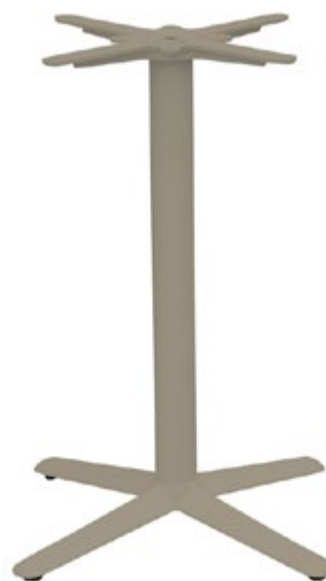

tortora:1553

Base per tavolo componibile 4 razze

Dimensioni: Ø60 x 75 (cm)

BASE CLIFTON



Nero:1319

Base doppia in ghisa per tavolo componibile
Dimensioni: 40X75X72 (cm)

BASE PIATTA



Tortora:1233

Antracite:1618

Basamento in acciaio – piede a piastra 40 x 40 cm – tubo acciaio
Dimensioni: 40X40H72

Acero:6589

 Basi componibili

BASE ELISA

Base **PIEGHEVOLE** e **ACCATASTABILE, AUTOLIVELLANTE*** in **ALLUMINIO**, dal design a quattro gambe che si aprono a ventaglio. Questa base offre una buona stabilità al tavolo anche quando è aperto. Inoltre è dotato di un meccanismo di chiusura che permette di ripiegare il piano verso il basso e di riporre il tavolo in posizione verticale quando non è in uso e di un **gancio porta borse**.

Dimensioni: 67xh72



© design registrato

 Tavoli autolivellanti

TAVOLI TETRIS

Tavolo in metallo verniciato a polvere nero, autolivellante, dal design minimal e geometrico. Si adatta a tutti gli ambienti.

Dimensioni:
80x60 h75 cm



Bianco:1244
Nero:1245

Tavoli autolivellanti TAVOLI TETRIS

Tavolo in metallo verniciato a polvere nero, autolivellante, dal design minimal e geometrico. Si adatta a tutti gli ambienti.

70x70

Bianco:1248



Grafite:1255



Nero:7870



Cuoio:1247



80x80

Bianco:1700



Grafite:1398



Nero:0829



Cuoio:1247



90x90

Bianco:1508



Nero: 1252

TAVOLI TETRIS

Tavolo in metallo verniciato a polvere nero, autolivellante, dal design minimal e geometrico. Si adatta a tutti gli ambienti.

Dimensioni:
150X80x h75 cm

Marrone:1251



Bianco:1253





Tavoli autolivellanti

TAVOLI TETRIS

Tavolo da bar snack in metallo verniciato a polvere nero, autolivellante, dal design minimal e geometrico.

Si adatta a tutti gli ambienti.

Dimensioni:

60x60xh110cm

70x70xh110 cm

80x80xh110 cm





Tavoli autolivellanti

TAVOLI TETRIS

Tavolo in metallo snack autolivellante

Dimensioni:
105X60XH110 (cm)

Bianco:8990



Nero:1039



Grigio:7144





Ourdoor

TAVOLINO TETRIS

Tavolo in metallo verniciato a polvere nero,
autolivellante, dal design minimal e geo-
metrico.

Si adatta a tutti gli ambienti.

Dimensioni:

150X80X H30 cm



UTILITY

Tavolo in metallo snack

Dimensioni:
105x60x110 (cm)

Grigio: 9652



Bianco: 9645





RIGLY

Tavolino 45 x 45 cm – polipropilene
con aggiunta di fibra di vetro – resi-
stente ai raggi uv

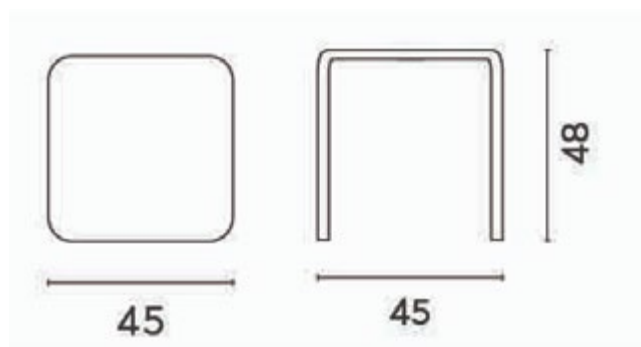

Antracite:1792



Bianco:1791



OUTDOOR *Collection*







LISBONA

Divano 2 posti con due poltrone in alluminio, cuscini sfoderabili inclusi

Dimensioni:

Divano: 156*89*82 cm

Poltrona: 82*86*82 cm

Tavolino: 130*73.5*38 cm

Grigio antracite :8530



Grigio antracite : 5478



MALAGA

Divano 3 posti con due poltrone in alluminio, cuscini sfoderabili inclusi

Dimensioni:

Divano: 187*96.8*80 cm

Poltrona: 82*93.8*80 cm

Bianco:7618



© design registrato

SET TENERIFE

Set composto da due poltrone, un divano a 2 posti e un tavolino con piano in alluminio Ø80 cm – struttura in alluminio creta – corda per esterni sabbia – cuscini sfoderabili ecru'

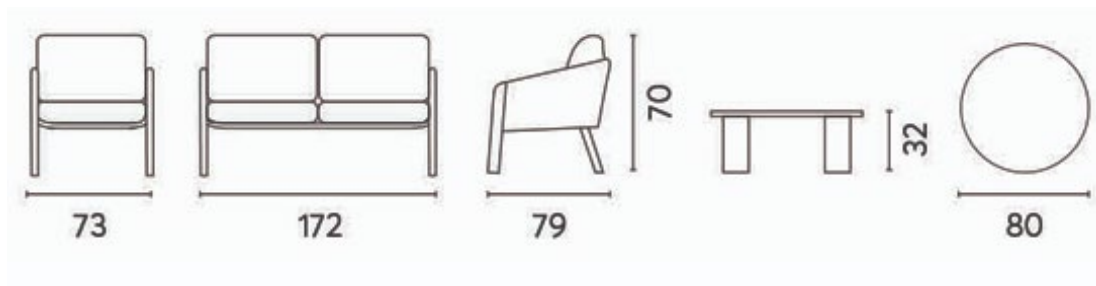

 Arredi Giardino

SET VENEZIA

Set composto da 2 poltrone, un divano 3 posti e un tavolino con piano in ceramic glass effetto cemento 110 X 60 X 40 cm - struttura in alluminio bianco - corda e cuscini sfoderabili grigio chiaro.

Struttura bianca/corda grigia:1685



 Arredi Giardino

KINOS

Set composto da 2 poltrone, 1 divano due posti e un tavolino con piano in ceramica, cuscini ecrù, struttura in ferro e braccioli effetto legno



rosso:8019



MARATEA

Set TARQUINIA – composto da 2 poltrone,
1 divano e 1 tavolino con piano in ceramic
glass ø 65 cm x 41 cm – textilene antracite
e struttura in ferro

Antracite:6734



Salvia:1549





Bianco : 8929

 Arredi Giardino
CORFÙ

Set in polipropilene dallo stile moderno e contemporaneo, composto da divano due posti, due poltrone e un tavolino.

Dimensioni:

poltrona 84x77x69xhs 35cm

divano: 150x77x69xhs 35

tavolino:150x77x69xhs35

IMPILABILE

Ambra:8899



 Arredi Giardino

SET NAPOLI

Set composto da 2 poltrone, un divano tre posti e un tavolino in legno di acacia con cuscini in tessuto bianchi.

Ecrù: ART01684



SET SICILIA

Set composto da 2 poltrone, un divano tre posti e un tavolino 120 x 65 x 32 cm - struttura in legno di acacia - corda antracite - con cuscini sfoderabili grigi

Acacia/ grigio: 1682



TARANTO

Set composto da 2 poltrone, un divano a 2 posti e un tavolino 110 x 65 x 40 cm, realizzato in rattan naturale. Cuscini in policotone ecrù sfoderabili.

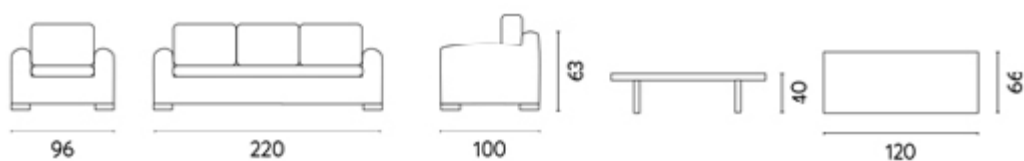

Rattan:0648



 Arredi Giardino

SET AVELLINO

Set composto da 2 poltrone, un divano due posti e un tavolino teak con cuscini in tessuto panna.

Teak:1685





Antracite:1547



EMPEDOCLE

Tavolo rettangolare allungabile in alluminio con doghe, verniciato a polvere epossidica. Perfetto per arredare ambienti interni ed esterni.

P. Ercole ospita dalle 10 / 12 persone.

Dimensioni: **200/300X102 cm**

bianco: 1548

3 m

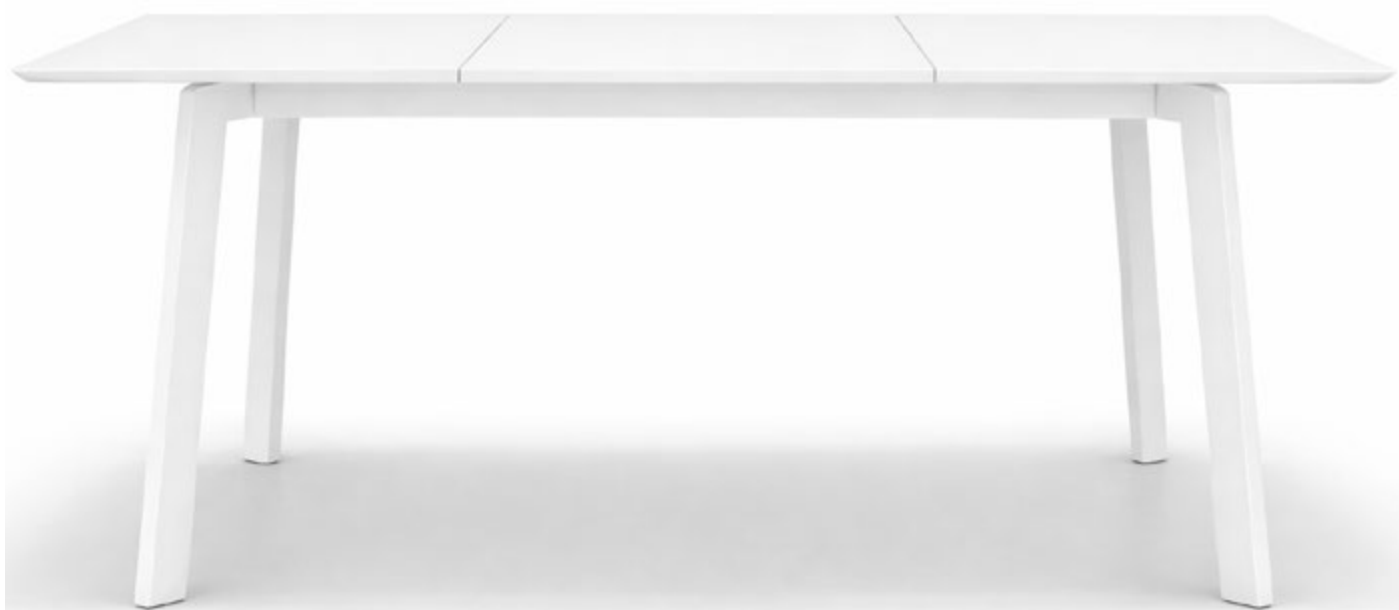

CORDOBA

Tavolo rettangolare allungabile in alluminio con doghe, verniciato a polvere epossidica.

Perfetto per arredare ambienti interni ed esterni.

Cordoba ospita dalle 4/6 persone.

Dimensioni: 82*163 x L. 90 x H 75 cm



Grigio: 0361



Bianco:0316

JEFF

Tavolo in alluminio allungabile, allun-
ghe con gambe scorrevoli, piano in
alluminio

Dimensioni: 100/150 x 150 cm

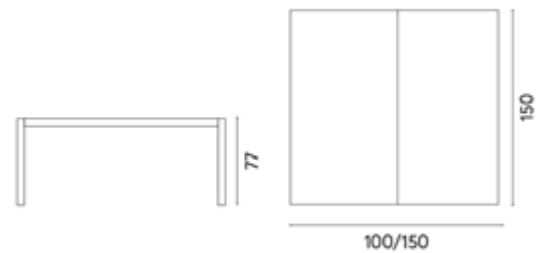

Antracite:6277





Antracite:1783

MYKONOS

Tavolo rettangolare allungabile in alluminio con doghe, verniciato a polvere epossidica.

Perfetto per arredare ambienti interni ed esterni.

P. Ercole ospita dalle 10 / 14 persone.

Dimensioni: **265/330/398*110**

Bianco:1686

4 m



SUTRA

Tavolo in teak allungabile
Dimensioni 180/250*100

Teak:1689



LIPSIA

Tavolo in teak ovale
Dimensioni: 120/170*120

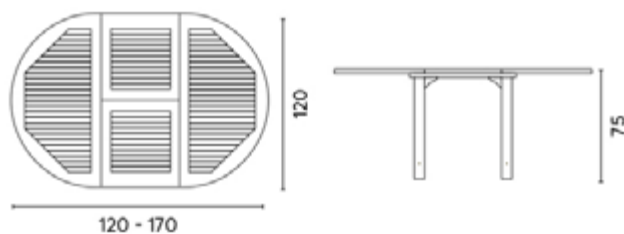

Teak: 1700

TAVOLO GIACA

Tavolo in teak rettangolare
Dimensioni: 250X100

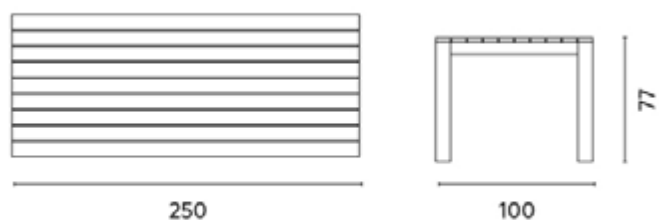

Teak:1690



TAVOLO SIRI

Tavolo ovale allungabile in teak

Dimensioni:
180/240*120

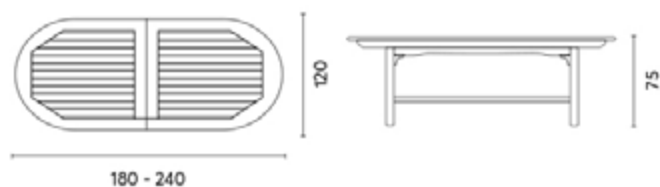

Teak:1697



SIRI

Sedia in teak pieghevole con cuscino ecrù

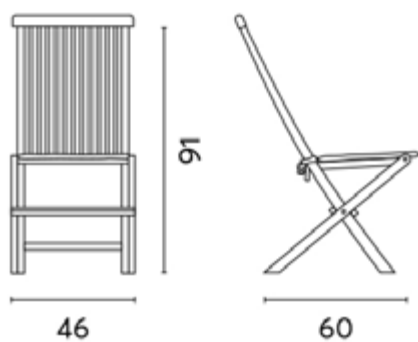

Teak/ cuscino ecrù: 1698



BANCONE BAR

Bancone bar in teak rettangolare con
poggia piedi

Dimensioni: 250x75x107 cm

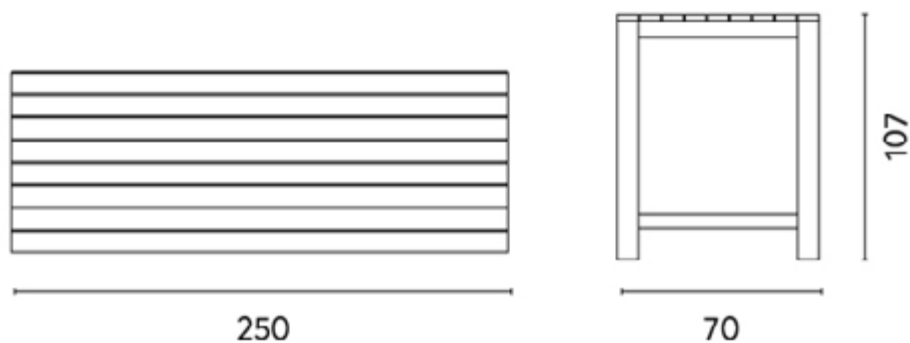

Teak:1691





 **PORTABICCHIERE**

- ✓ Integrato nel piano
- ✓ Struttura stabile e discreta
- ✓ Ideale per ambienti outdoor e contract

 **PORTA TELEFONO**

- ✓ Alloggiamento ergonomico
- ✓ Accesso immediato al dispositivo
- ✓ Perfetto per momenti di relax

LETTINO DUBAI

Lettino prendisole monoblocco, dal design scultoreo e fluido, con linee continue e sinuose.

La struttura è in materiale plastico stampato (look resina), finito bianco opaco/lucido, con superficie liscia e pulita.

La seduta è ergonomica, con profilo ondulato che accompagna il corpo: zona gambe allungata, seduta centrale incavata e schienale integrato leggermente rialzato.

Base piena e stabile, senza braccioli, senza cuscini, stile minimale e contemporaneo.

Dimensioni:
183*83.5*71

Bianco:9832



© design registrato



LETTINO TAO

struttura in alluminio creta e
textilene sabbia – cuscino beige
idrorepellente

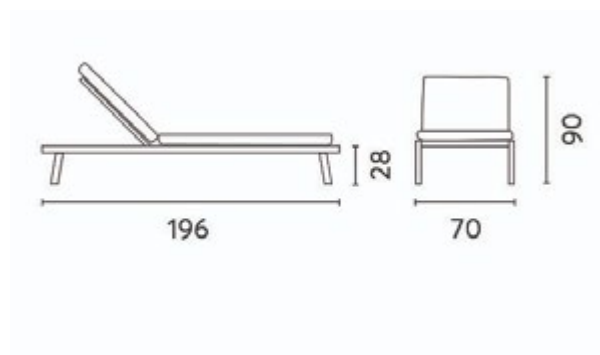

Creta\sabbia:1787





Bianco:9058

BARCELLONA

Lettino da esterno con struttura in alluminio verniciato a polvere, seduta e schienale in textilene imbottito.

Dimensioni:
B 190 x P 70 x H 30

Grigio\bianco: 1701



Tortora\bianco: 9065



LETTINO SIESTA

Lettino da spiaggia in legno mango.

Legno:8233



LETTINO NAPOLI

Lettino in legno di acacia con
finitura in color TEAK - con cuscino
sfoderabili sabbia

Acacia/bianco:1883



SDRAIO MARE

Sdraio mare pieghevole con struttura
in alluminio con textilene e cuscino

Dimensioni:
tubo 35x18 mm

Tortora:1556

Grigio:1555



Grigio:1290



KONA

Il dondolo ha una forma a goccia/ovale, con una struttura intrecciata che crea un effetto leggero e arioso. La seduta è ampia e avvolgente, progettata per offrire comfort, ed è completata da cuscini morbidi e imbottiti che riempiono l'interno.

È sospeso tramite un gancio e una catena collegati a una struttura curva con base circolare, che permette al dondolo di oscillare liberamente. Il design combina linee morbide e moderne con un intreccio decorativo che rende il pezzo elegante e adatto a spazi relax sia interni che esterni.

Dimensioni:

base: Diam108xH198 seduta104x73xH117



Beige:4321

 Arredi da giardino

DAYBED

lettino 205 x 186 x h. 200 cm - schienale doppio reclinabile -
cuscini in PVC grigio chiaro - struttura alluminio BIANCO 80
x 80 mm - tende in poliestere 180 gr. grigio chiaro - tetto in
textilene bianco



 Arredi da giardino

PERGOLA

Pergola con struttura alluminio e tetto scorrevole
3x3



bianco: 0876 - 1 pz

PERGOLA

Pergola con struttura alluminio (3*4) 4 pilastri
tetto lamellare orientabile tramite manovella – altezza max. 2,50 mt – sistema di
scarico
dell'acqua integrato all'interno dei pali portanti



PERGOLA

Pergola con struttura alluminio (3*6) 6 pilastri

bianco: 1695





OMBRELLONE MACRAME' ROTONDO

Ombrellone macrame' Ø 2,5 mt. – fusto legno Ø 48/8 – doppia carrucola – bacchette
17 X 35 mm – altezza max. con base 2,64 mt – copertura rete e frangia

H max 2,64 m

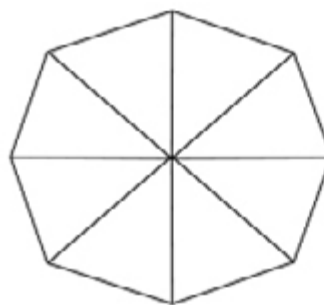

250

Corda:1786



OMBRELLONE AROMA

3*3
BIANCO

Caratteristiche tecniche:

- Telo 3x3 m in tessuto da 250g in poliestere (trattato in PA).
- Palo centrale in alluminio misura: 93x57 mm
- 8 solide stecche della misura di 28x18 mm
- Sistema di apertura retrattile che permette la chiusura parallela al palo.
- Maniglia per spostamento agevolato del telo e inclinazione in 4 posizioni
- Il palo girevole con pedale permette all'ombrellone di ruotare di 360°
- Camino antivento per una maggiore stabilità.
- Cover copri telo inclusa



3*4
BIANCO
O GRIGIO



 Arredi da giardino

OMBRELLONE DOPPIO

Ombrellone doppio p.laterale antracite con telo ecrù
3*3H2.60 3*3H2.60





CRIBEL S.r.l. a socio unico
Via per Grottaglie, km 1.800 z.i.
72021 Francavilla Fontana (BR) - ITALY
tel. +39 0831 821040

www.cribel.it
www.ordini@cribel.it