

Drama *Aprile* Collezione 2026



 | CRIBEL®
industrie per l'arredamento

1.	<i>-Set tavoli e sedie</i>	6
	<i>-Tavoli in ceramica</i>	40
	<i>-Tavoli in legno</i>	64
	<i>-Tavoli in vetro</i>	77
	<i>-Tavoli contract</i>	78
2.	<i>-Poltrone e sedie</i>	84
	<i>-Sgabelli</i>	158
	<i>-Poltrone relax</i>	176
	<i>-Poltrone e divani</i>	186
	<i>-Sedute ufficio</i>	204
3.	<i>-Tavolini</i>	212
	<i>-Specchi</i>	232
	<i>-Consolle e madie</i>	236
	<i>-Piani e tavoli componibili</i>	238
4.	<i>-Outdoor</i>	262

Super Promo

1 tris €785

2 tris €670

tavoli allungabili

Dimensioni da chiuso: 160 x 90 x 75 cm

Dimensioni da aperto: 240 x 90 x 75 cm



Dimensioni da chiuso: 180 x 90 x 75 cm

Dimensioni da aperto: 260 x 90 x 75 cm



Dimensioni da chiuso: 160 x 90 x 75 cm

Dimensioni da aperto: 240 x 90 x 75 cm



Super Promo

1 tris €400

2 tris €225

tavoli Fissi

Dimensioni: 140*80*75



Dimensioni: 140*80*75



Dimensioni: DIA 120*75



SET
TAVOLI & SEDIE
Collection





Tortora:1500



SET XILON

Tavolo Estensibile con apertura laterale. Piano in Laminato e Allunghe in Alluminio, gambe ad incrocio in metallo. Sedie realizzate interamente in polipropilene.

Dimensioni da chiuso: 180 x 90 x 75 cm

Dimensioni da aperto: 260 x 90 x 75 cm

SPESSORE PIANO 9 CM

● 4  +  **Prezzo promo €490** **Prezzo promo €425** **ORDINE MIN 2 SET (1 x colore)**

ALTRI COLORI DISPONIBILI:

Anracite:9506



Top rovere / nere :6732



Bianca:9490



Top rovere / bianche: 6749







Set tavoli allungabili e sedie

SET ANSON C/6 SEDIE

Tavolo Estensibile con apertura centrale. Piano in Laminato e Allunghe in Alluminio, gambe ad incrocio in metallo.

Sedia in velluto arricchita da decori sullo schienale e gambe in metallo.

Dimensioni da chiuso: 160 x 90 x 75 cm

Dimensioni da aperto: 240 x 90 x 75 cm

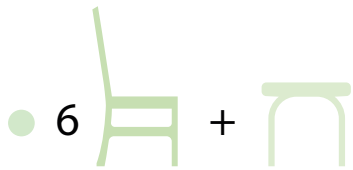

6

Prezzo promo

€365

Prezzo promo

€300

ORDINE MIN 3 SET

Senape:9153



Blu:9160



Ruggine:9177



ALTRI COLORI DISPONIBILI:

Top bianco / bianco : 6190







Set tavoli allungabili e sedie

SET VERMONT

Il piano del tavolo è realizzato in gres porcellanato effetto marmo, le gambe in metallo dalla forma geometrica a trapezio inclinato conferiscono al tavolo un aspetto moderno e imponente, garantendo al tempo stesso una stabilità ottimale. Sedia da pranzo, in velluto, gambe sottili in metallo.

Dimensioni da chiuso: 160 x 90 x 75 cm

Dimensioni da aperto: 240 x 90 x 75 cm

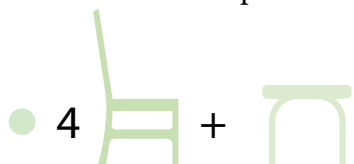

Prezzo promo

€375

Prezzo promo

€315

ORDINE

MIN 2 SET

ALTRI COLORI DISPONIBILI:

Velluto porpora



velluto verde :6312



Tessuto petrolio :8684



Tessuto cenere:8639



Top bianco con venature /gambe bianche : 6701





Set tavoli fissi e sedie

SET POINT C/6 SEDIE

Tavolo Fisso con piano rettangolare con angoli leggermente stondati, realizzato in gres porcellanato

con venature grigie. La base è composta da gambe in metallo verniciato nero opaco, disposte in modo incrociato. La sedia è realizzata in velluto con chevron sullo schienale e gambe in metallo nere.

Dimensioni:

140*80*75

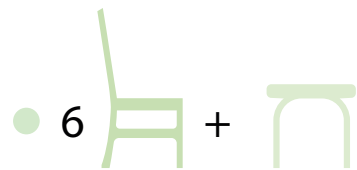

Prezzo promo

€290

Prezzo promo

€225

ORDINE MIN 2 SET

Top bianco con venature /gambe nere : 6398

Velluto blu:8644



 Set tavoli fissi e sedie

SET TEXAS

Tavolo Fisso con piano rettangolare con angoli leggermente stondati, realizzato in gres porcellanato

con venature grigie. La base è composta da gambe in metallo verniciato nero opaco, disposte in modo incrociato. La sedia è realizzata in tessuto con uno schienale arrotondato, rombi sul retro dello schienale e gambe in metallo nere.

Dimensioni:

140*80*75



Prezzo promo

€325

Prezzo promo

€195

ORDINE MIN 2 SET

Top bianco con venature /gambe nere : 6398

Tessuto Verde:7227







Set tavoli fissi e sedie

SET ROYAL C/6 SEDIE

Il tavolo presenta un piano effetto marmo bianco con venature grigio chiaro, dall'aspetto raffinato e moderno. La struttura centrale in metallo nero con base a X incrociata conferisce forte carattere estetico, stabilità e un look architettonico deciso, perfetto per ambienti moderni e contract. Sedia da pranzo, in tessuto moztart o tessuto.

Dimensioni:

160*90*75



Prezzo promo

Prezzo promo

€335

€280

ORDINE MIN 2 SET

ALTRI COLORI DISPONIBILI:



Mozart
tortora :5560



Mozart
grigio :1463



Mozart
fango :1432



Tessuto
grigio:6550



Tessuto
bordeaux:6031



Tessuto
verde:5751

Top bianco con venature /gambe nere : 6763







Set tavoli fissi e sedie

SET FOUND

New!!!

Set pranzo dal design moderno ed elegante, composto da tavolo tonalità kashmir/beige, dagli angoli stondati e 4 gambe nere.

Le sedie sono rivestite in velluto, morbido al tatto e visivamente caldo, con schienale avvolgente e seduta confortevole. Anche le sedie poggiano su gambe in metallo nero

Dimensioni:

Tavolo: 140*80*76

Sedia: 44*52*85

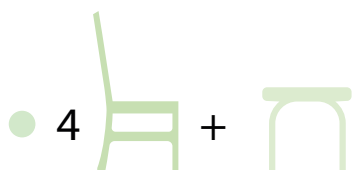

Prezzo promo

€200

Prezzo promo

€135

ORDINE MIN

3 SET

(1 x finitura)

Piano Pandora /sedie senape:9320



ANGOLI STONDATI



Piano Pandora/sedie nere:9313



Piano Pandora/sedie verde smeraldo:9306





Ruggine: 6123



Set tavoli fissi e sedie

SET BRIGITTE

New!!!

Set composto da tavolo con piano tondo finitura pandora e gambe centrali incrociate bronzo.

4 poltrone imbottite con gambe in metallo nere.

Dimensioni:

DIA 120*75



Prezzo promo

€325

ALTRI COLORI DISPONIBILI:

Genere: 6147



Verde: 7401

Top Pandora /gambe bronzo : 9740





Tortora:9139



Set tavoli fissi e sedie

SET ROYAL C/6 SEDIE

Il tavolo presenta un piano effetto marmo bianco con venature grigio chiaro, dall'aspetto raffinato e moderno. La struttura centrale in metallo nero con base a X incrociata conferisce forte carattere estetico. La sedia è realizzata in velluto trapuntato e gambe in metallo nere.

Dimensioni:

160*90*75

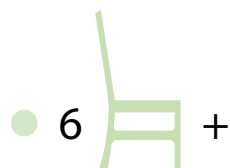

Prezzo promo

€270

Prezzo promo

€210

Fango:9146



Senape:9153



Petrolio:9160



Ruggine:9177



ORDINE MIN 2 SET

ALTRI COLORI DISPONIBILI:

Top bianco con venature /gambe nere : 6763



SET IGOR

Il tavolo presenta un piano effetto marmo bianco con venature grigio chiaro, dall'aspetto raffinato e moderno. La struttura centrale in metallo nero con base a X incrociata conferisce forte carattere estetico, stabilità e un look architettonico deciso, perfetto per ambienti moderni e contract.

La sedia è realizzata in velluto con uno schienale arrotondato, rombi sul retro dello schienale e gambe in metallo nere.

Dimensioni:

160*90*76

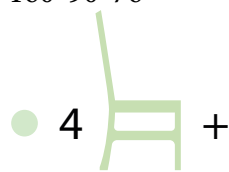

Prezzo promo

€358

Prezzo promo

€235 ORDINE MIN 2 SET

Top bianco con venature /gambe bianche : 9085

Cipria:8958





Set tavoli fissi e sedie

SET SINTRA

Tavolo Fisso con piano rettangolare con angoli leggermente stondati, realizzato in gres porcellanato con venature grigie. La base è composta da gambe in metallo verniciato nero opaco.

La sedia è realizzata in tessuto o velluto con uno schienale arrotondato e gambe in metallo nere.

Dimensioni:

140*90*76

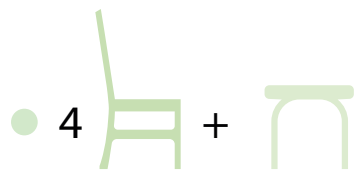

Prezzo promo

€112

Top bianco con venature /gambe nere : 7647

Vinaccio/porpora



 Set tavoli fissi e sedie

SET ARBUSTO C/6 SEDIE

Tavolo rettangolare con base in metallo e **piano massello**, Il tavolo ha una forma rettangolare, classica ed elegante, che si adatta a diverse tipologie di ambienti. La base è costituita da una struttura in metallo, **spessore del tavolo 8 cm.**

La sedia è realizzata in velluto con un motivo chevron sullo schienale e gambe in metallo nere.

Dimensioni:
180*90*76

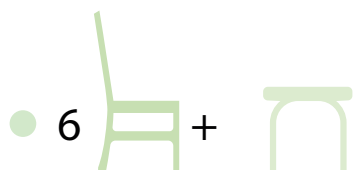

Prezzo promo Prezzo promo
€430 €358

ORDINE MIN 2 SET

Velluto blu:8644

Piano massello/ gambe nere : 0725



 Set tavoli fissi e sedie

SET MARBLE *New!!!*

Tavolo Estensibile con Piano Effetto Rovere , Stile Nordico e Funzionalità Moderna. La struttura in metallo con gambe affusolate inclinate conferisce un tocco retrò e al contempo moderno, garantendo solidità e stabilità.
4 sedie realizzate interamente in metacrilato.

Dimensioni da chiuso: 160 x 90 x 75 cm

Dimensioni da aperto: 220 x 90 x 75 cm

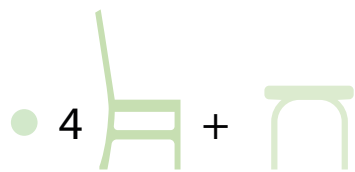

Prezzo promo

€335

Top rovere /gambe nere :4404

Trasparente:9788





 Set tavoli fissi e sedie

SET BENNY C/6 SEDIE

Set composto da un tavolo con struttura in metallo laccato e top in vetro e da 6 sedie in velluto trapuntato gambe nere.

Dimensioni tavolo: 140x80x75 (cm)

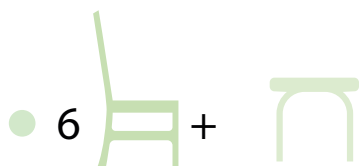

Prezzo promo **€245** Prezzo promo **€185** ORDINE
MIN 2 SET

ALTRI COLORI DISPONIBILI:

Senape:9153



Petrolio:9160



Tortora:9139



Piano vetro / gambe nere:0985



Piano vetro / gambe bianche : 5850

Bianca:0992



 Set tavoli fissi e sedie

SET CHAPEAU

Questo tavolo presenta un design minimalista e moderno, perfetto per ambienti contemporanei e versatili. Struttura verniciata bianca, piano in vetro temperato bianco. Sedia impilabile realizzata interamente in polipropilene.

Dimensioni:
140*80*75 (cm)

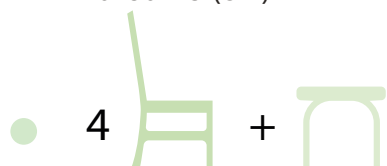

Prezzo promo

€175

Prezzo promo

€125 ORDINE
MIN 2 SET

ALTRI COLORI DISPONIBILI:

Piano vetro / gambe silver:9078

Tortora:1012



Piano vetro / gambe nere:0985

Nera:1005



 Set tavoli fissi e sedie

SET BENNY C/6 SEDIE

Set composto da un tavolo con struttura in metallo laccato e top in vetro e da 6 sedie in polipropilene.

Dimensioni tavolo: 140x80x75 (cm)

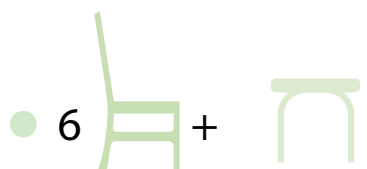

Prezzo promo

€225

Prezzo promo

€123

ORDINE

MIN 4 SET

Salvia: 6169

Piano vetro / gambe nere: 0985





Set tavoli fissi e sedie

SET BELLA

Tavolo Fisso con piano rettangolare con angoli leggermente stondati, realizzato in gres porcellanato con venature grigie. La base è composta da gambe in metallo verniciato nero opaco.

Sedia impilabile realizzata interamente in polipropilene.

Dimensioni:

140*80*75 (cm)

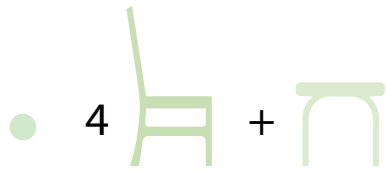

Prezzo promo

€212

Prezzo promo

€180

ORDINE
MIN 2 SET

Antracite:8217

Top bianco con venature /gambe nere : 7647





Set tavoli fissi e sedie

SET CORDOBA C/6 SEDIE

Il tavolo è un modello rettangolare dal design essenziale, con struttura in metallo verniciato bianco e linee pulite e squadrate. Il piano è in vetro temperato. Sedie in polipropilene bianche.

Dimensioni:

H75*D80*W140

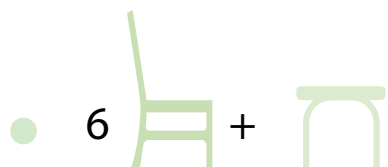

Prezzo promo

€207

Prezzo promo

€170

ORDINE

MIN 3 SET

Bianco:5850

Bianco:9568





Set tavoli fissi e sedie

SET TETRIS

Tavolo autolivellante con struttura essenziale in metallo, con linee pulite e gambe perimetrali squadrate che garantiscono stabilità e un'estetica rigorosa. La finitura scura uniforme dona eleganza e solidità visiva, rendendolo adatto sia a contesti residenziali contemporanei sia a spazi professionali come ristoranti e sale pranzo. Sedie in polipropilene dal design minimal e funzionale, con schienale leggermente curvato e taglio orizzontale che alleggerisce la struttura e migliora l'ergonomia.

Dimensioni:
150*80*75 (cm)

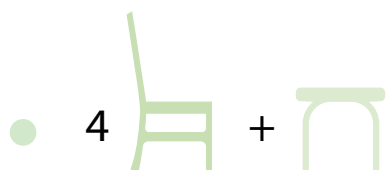

Prezzo promo

Prezzo promo

€325

€245

ORDINE MIN 2 SET

Antracite:1254

Antracite:8217



Bronzo:7098

Bronzo:1251





Set tavoli fissi e sedie

SET BENNY

Set composto da un tavolo con struttura in metallo laccato e top in vetro e da 4 sedie con struttura in metallo, seduta e schienale con imbottitura in poliuretano e rivestimento in similpelle.

Posti a sedere 4.

Dimensioni tavolo: 140x80x75 (cm)

Dimensioni sedie: 40.5x51x96

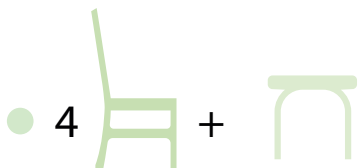

Prezzo promo **Prezzo promo**

€180

€123

ORDINE
MIN 4 SET

Cenere/
Bianco
9106





Set tavoli fissi e sedie

SET QUEEN C/6 SEDIE

Set composto da tavolo con gambe bianche e piano in vetro e 6 sedie ib ecopelle con gambe in alluminio bianche

Posti a sedere 6.

Dimensioni tavolo:

H75*D80*W140

Dimensioni sedie:

40*47*96 (cm)

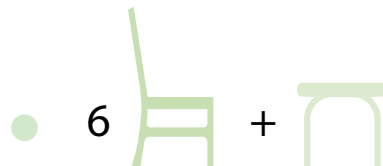

Piano vetro / gambe nere: 0985
nera / gambe nere: 5362

Prezzo promo Prezzo promo

€212

€135 ORDINE
MIN 4 SET



bianca/ gambe all:0022

Piano vetro / gambe silver : 9078





Set tavoli fissi e sedie

SET INDUSTRIAL

Set composto da tavolo quadrato e 4 sedie coordinate in metallo verniciato bianco.

Tavolo, con piano quadrato con bordo sottile e lineare, struttura in metallo con gambe leggermente inclinate e rinforzo centrale a croce.

Sedie: design monoscocca in metallo

Posti a sedere 4.

Dimensioni tavolo: 80*80*75

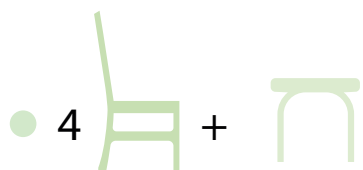

Prezzo promo **Prezzo promo**

€257

€180

ORDINE
MIN 2 SET

Bianco:7591

Bianco:6824





Set tavoli fissi e sedie

SET SUNNY

Set composto da tavolo quadrato e quattro sedie monoscocca in polipropilene.

Il tavolo in metallo verniciato bianco presenta un piano pulito e lineare, sostenuto da una struttura centrale con gambe curve che garantiscono stabilità e leggerezza visiva.

Posti a sedere 4.

Dimensioni tavolo: 70*70*71

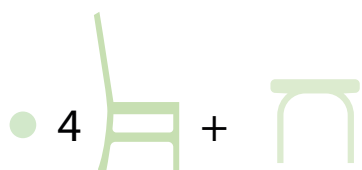

Prezzo promo

€140

Bianco:6947

Bianco:0376



TAVOLI

Collection





Super Promo

1 tris €785

2 tris €670

tavoli allungabili

Dimensioni da chiuso: 160 x 90 x 75 cm

Dimensioni da aperto: 240 x 90 x 75 cm



Dimensioni da chiuso: 180 x 90 x 75 cm

Dimensioni da aperto: 260 x 90 x 75 cm



Dimensioni da chiuso: 160 x 90 x 75 cm

Dimensioni da aperto: 240 x 90 x 75 cm



Super Promo

1 tris €400

2 tris €325

tavoli Fissi

Dimensioni: 140*80*75



Dimensioni: 140*80*75



Dimensioni: DIA 120*75



ESTENDIBILE CON ALLUNGHE LATERALI



TOP PANDORA





Tavoli in ceramica

GEORGE

New!!!

Tavolo da pranzo allungabile con allunghe esterne in Gres Porcellanato Effetto Marmo. La struttura in metallo verniciato si distingue per le gambe incrociate a design scultoreo, che donano stabilità e un'estetica ricercata.

posti a sedere: 6 da chiuso / fino a 10 da aperto.

Dimensioni da chiuso: 160 x 90 x 75 cm

Dimensioni da aperto: 240 x 90 x 75 cm

Prezzo promo

€435

ALTRI COLORI DISPONIBILI:

Top bianco lucido /gambe bianche:9658



Top patagonia nero ven gold opaco /gambe nere:9641



Top Pandora /gambe bronzo:9627



 Tavoli in ceramica

PEGASO

Tavolo da pranzo allungabile con allunghe esterne in Gres Porcellanato Effetto Marmo. La struttura in metallo verniciato oro si distingue per le gambe incrociate a design scultoreo, che donano stabilità e un'estetica ricercata.

posti a sedere: 6 da chiuso / fino a 10 da aperto.

Dimensioni da chiuso: 160 x 90 x 75 cm

Dimensioni da aperto: 240 x 90 x 75 cm

Prezzo promo

€415

ESTENDIBILE CON ALLUNGHE LATERALI

Top nero con venature oro /gambe Oro satinato:6727



© design registrato

 Tavoli in ceramica

FLORIDA

Il piano è realizzato in gres porcellanato opaco. Dotato di un sistema di estensione rotante, il tavolo si trasforma con un semplice gesto. Le gambe incrociate in metallo garantiscono stabilità e un impatto visivo di forte personalità.

Posti a sedere: 4-6 da chiuso, fino a 8 da aperto

Dimensioni da chiuso: 130 x 90 x 76 cm

Dimensioni da aperto: 190 x 90 x 76 cm

Prezzo promo

€358

ESTENDIBILE CON SISTEMA DI ROTAZIONE

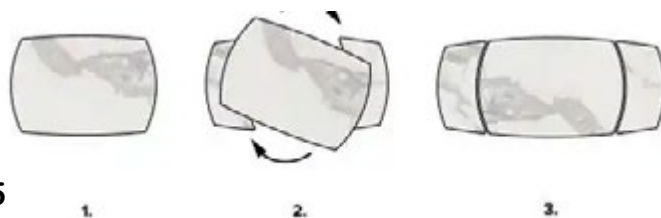

Top bianco con venature /gambe bianche: 6435



Top bianco con venature /gambe bianche : 6701





Tavoli in ceramica
VERMONT

Il piano del tavolo è realizzato in gres porcellanato effetto marmo, le gambe in metallo dalla forma geometrica a trapezio inclinato conferiscono al tavolo un aspetto moderno e imponente, garantendo al tempo stesso una stabilità ottimale.

Posti a sedere: 6 da chiuso / fino a 10 da aperto.

Dimensioni da chiuso: 160 x 90 x 75 cm

Dimensioni da aperto: 240 x 90 x 75 cm

Prezzo promo	Prezzo promo	
€448	€280	ORDINE MIN 2PZ

ESTENDIBILE CON ALLUNGHE LATERALI

© design registrato



 Tavoli in ceramica

BRIGE *New!!!*

Tavolo allungabile con piano in Gres Porcellanato Effetto Marmo lucido, caratterizzato da un design contemporaneo ed essenziale. La struttura in metallo assicura solidità e stabilità, mentre le gambe inclinate e slanciate conferiscono leggerezza visiva e un segno moderno.

Il piano in ceramica, sottile e resistente, è impreziosito da delicate venature

Posti a sedere: 4-6 da chiuso, fino a 8 da aperto

Dimensioni da chiuso: 140 x 90 x 76 cm

Dimensioni da aperto: 210 x 90 x 76 cm

Prezzo promo

€280

ALTRI COLORI DISPONIBILI:

ESTENDIBILE CON ALLUNGHE LATERALI

Top Pandora/gambe brozo: 9696



Top patagonia nero opaco con venat: 9689





 Tavoli in ceramica

ARTEMIDE *New!!!*

Tavolo dal design contemporaneo con piano dalla forma morbida e bordi arrotondati, caratterizzato da una superficie continua ed elegante. La struttura è composta da due basi centrali dalla geometria inclinata e scultorea, che garantiscono stabilità e forte presenza visiva senza appesantire l'insieme.

Posti a sedere: 4-6

Dimensioni da chiuso: 150 x 90 x H76 cm

Dimensioni da aperto: ø' 150 H76 cm

Prezzo promo

€480

ESTENDIBILE CON ALLUNGHE LATERALI

ALTRI COLORI DISPONIBILI:

Top nero opaco: 9405



Top Pandora/gambe bronzo: 9368







Tavoli in ceramica

SHUTTLE *New!!!*

Tavolo dal design contemporaneo con piano rotondo in Gres Porcellanato Effetto Marmo, meccanismo di rotazione integrato che consente di azionare l'allunga in modo fluido e intuitivo. La base centrale è dotata di un meccanismo robusto e ben integrato, da cui si diramano quattro gambe inclinate che garantiscono stabilità e slancio alla struttura.

Posti a sedere: 4-6 da chiuso, fino a 8 da aperto

Dimensioni da chiuso: 150 x 90 x H76 cm

Dimensioni da aperto: ø' 150 H76 cm

Prezzo promo

€525

ESTENDIBILE CON SISTEMA DI ROTAZIONE

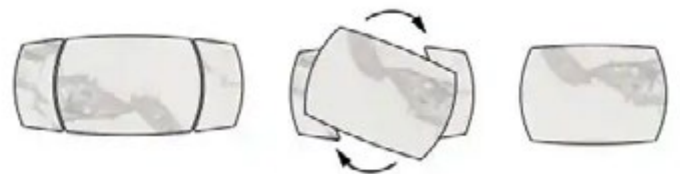

Top nero opaco: 9702



Top bianco lucido: 7002



TEXAS

Tavolo Fisso con Piano in Gres Porcellanato Effetto Marmo, La struttura in metallo, con gambe inclinate dal profilo sottile e dinamico, conferisce stabilità e leggerezza visiva al tavolo. Con dimensioni compatte, è perfetto per cucine, living moderni o angoli pranzo in ambienti open space.

Posti a sedere: 4.

Dimensioni: 140 x 80 x 75 cm

Prezzo promo

€225

Prezzo promo

€100

ORDINE MIN
2 PZ

Top bianco con venature /gambe nere : 6398



AURA

Tavolo Fisso con piano rettangolare con angoli leggermente stondati, realizzato in gres porcellanato piano lucido con venature grigie. La base è composta da gambe in metallo verniciato nero opaco, disposte in modo incrociato e dinamico, creando un effetto scultoreo e di forte impatto estetico.

Stile contemporaneo e versatile, adatto sia a living moderni sia a zone pranzo eleganti e di design.

Aura saprà accogliere dalle 6-8 persone .

Posti a sedere:8.

Dimensioni:
180X85X75(cm)

Prezzo promo

€200

Top patagonia lucido /gambe nere :5768



Top Pandora /gambe bronzo : 9740



 Tavoli in ceramica

ROYAL *New!!!*

Tavolo Fisso con Piano in Gres Porcellanato Effetto Marmo. La base in metallo con gambe incrociate asimmetriche conferisce al tavolo un forte carattere architettonico e una stabilità solida.
Royal saprà accogliere dalle 6-8 persone .

Dimensioni:
DIA 120*75

Prezzo promo

€180

Top bianco con venature /gambe nere : 0041



ROYAL MIDI

Tavolo Fisso con Piano in Gres Porcellanato Effetto Marmo. La base in metallo con gambe incrociate asimmetriche conferisce al tavolo un forte carattere architettonico e una stabilità solida. Royal saprà accogliere 4 persone .

Dimensioni:
DIA 90X75

Prezzo promo

€123

Top bianco con venature /gambe nere : 6756- 3pz



ROYAL

Tavolo Fisso con Piano in Gres Porcellanato Effetto Marmo. La base in metallo con gambe incrociate asimmetriche conferisce al tavolo un forte carattere architettonico e una stabilità solida. Royal saprà accogliere dalle 6-8 persone .

Posti a sedere: 6.

Dimensioni:
160X90X75(cm)

Prezzo promo **Prezzo promo**

€212

€135 ORDINE MIN
2 PZ

Top bianco con venature /gambe nere : 6763



 Tavoli in ceramica

IGOR

Tavolo rettangolare con base in metallo e piano in gres porcellanato effetto marmo bianco con finitura opaca,

La combinazione di bianco e nero crea un contrasto visivo elegante e contemporaneo.

Il piano bianco luminoso si sposa perfettamente con la base nera, creando un look sofisticato e versatile.

Posti a sedere: 6.

Dimensioni: 160 x 90 x 75 cm

Prezzo promo **Prezzo promo**

€190

€155 ORDINE MIN
2 PZ

Top bianco con venature /gambe bianche : 9085



 Tavoli in ceramica

SINTRA

Tavolo Fisso 4 gambe in metallo con Piano in Gres Porcellanato Effetto Marmo. Con dimensioni compatte, è perfetto per cucine, living moderni o angoli pranzo in ambienti open space.

Posti a sedere: 4.

Dimensioni: 140*80 x 75h

Prezzo promo ~~Prezzo promo~~

€145

€78 ORDINE MIN
5 PZ

Top bianco con venature /gambe nere : 7647





 Tavoli in laminato allungabili

SPIRIT *New!!!*

Tavolo estendibile da pranzo dal design contemporaneo, caratterizzato da un piano rotondo in nobilitato con bordo pieno e da una struttura centrale in metallo con gambe incrociate che garantiscono stabilità e solidità.

Posti a sedere: 8 da chiuso / fino a 10 da aperto.

Dimensioni da chiuso: ø120 H75 cm

Dimensioni da aperto: 160 x 120 x H75 cm

Prezzo promo

€325

Top rovere /gambe nere :9764





 Tavoli in legno allungabili

IAGO

Un tavolo dal design deciso e contemporaneo, caratterizzato da un imponente piano in legno MASSELLO effetto naturale da 4 cm che dona calore e matericità all'ambiente. La base in metallo verniciato nero, composta da elementi geometrici intrecciati, conferisce stabilità e un forte impatto estetico, trasformando il tavolo in un vero elemento d'arredo. (Allunghe non integrate, da tenere aparte)
Posti a sedere: 6/8.

Dimensioni:
160(40+40)*90*76

Prezzo promo

€665

Top rovere /gambe nere : 5720



© design registrato

Top rovere / gambe nere :6732





Tavoli in legno allungabili

XILON

Tavolo Estensibile con Piano in Laminato e Allunghe in Alluminio – Stile Rustico Contemporaneo.

Le gambe incrociate in metallo creano una base solida e visivamente accattivante, che richiama lo stile industriale con un tocco di artigianalità rustica.

Posti a sedere: 8 da chiuso / fino a 10 da aperto.

Dimensioni da chiuso: 180 x 90 x 75 cm

Dimensioni da aperto: 260 x 90 x 75 cm

SPESSORE PIANO 9 CM

Prezzo promo

€336

Prezzo promo

€280 ORDINE MIN
2 x finitura

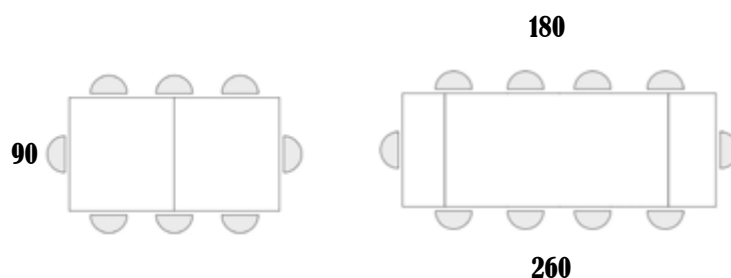

Top rovere / gambe bianche :6749







Tavoli in legno allungabili

XILON MAXI

Tavolo estendibile con piano in laminato, **allunghe in alluminio** gambe incrociate in laminato, questo aggiunge un tocco di modernità al tuo arredamento. Xilon saprà accogliere dalle 10-16 persone (200-400X100X76 cm)

Posti a sedere: 8 da chiuso / fino a 14 da aperto.

Dimensioni da chiuso: 200 x 100 x 75 cm

Dimensioni da aperto: 400 x 100 x 75 cm

SPESSORE PIANO 9 CM

Prezzo promo **Prezzo promo**

€505

€392

ORDINE MIN

1 x finitura

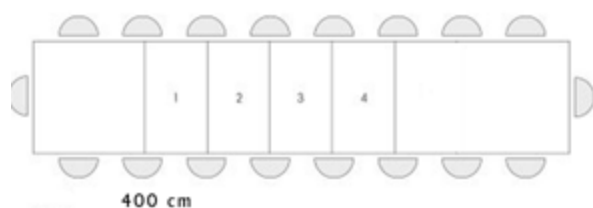

Top rovere / gambe bianche:6725





Top rovere / gambe bianche : 6062

ANSON

Tavolo allungabile con top in legno, **allunghe in alluminio** gambe centrali ad incrocio in metallo verniciato nero o bianche a polvere epossidica. Si allunga con facilità.

Posti a sedere: 6 da chiuso / fino a 8 da aperto.

Dimensioni da chiuso: 160 x 90 x 75 cm

Dimensioni da aperto: 240 x 90 x 75 cm

Prezzo promo **Prezzo promo**

€268

€200

ORDINE MIN 8PZ
4 PZ x finitura

Top bianco / gambe bianche : 6190



 Tavoli in legno allungabili

MARBLE

Tavolo Estensibile con Piano Effetto Rovere , Stile Nordico e Funzionalità Moderna. La struttura in metallo con gambe affusolate inclinate conferisce un tocco retrò e al contempo moderno, garantendo solidità e stabilità.

Posti a sedere: 6 da chiuso / fino a 8 da aperto.

Dimensioni da chiuso: 160 x 90 x 75 cm

Dimensioni da aperto: 220 x 90 x 75 cm

Prezzo promo

€245

Top rovere /gambe nere :4404



 Tavoli in legno fissi

ARBUSTO

Tavolo rettangolare con base in metallo e **piano massello**, Il tavolo ha una forma rettangolare, classica ed elegante, che si adatta a diverse tipologie di ambienti. La base è costituita da una struttura in metallo, **spessore del tavolo 8 cm.**

Posti a sedere: 6.

Dimensioni:
180X90X76(cm)

Prezzo promo **Prezzo promo**

€325

€225 ORDINE
MIN 2 PZ

Piano massello/ gambe nere : 0725



 Tavoli in legno fissi

EDWIN

Funzionalità e stile si incontrano in questo tavolo da pranzo dalle linee pulite e contemporanee.

Il piano effetto rovere con raffinata lavorazione chevron dona un tocco decorativo distintivo, mentre le gambe in metallo nero assicurano stabilità e un contrasto moderno che valorizza qualsiasi ambiente.

Posti a sedere 4.

Dimensioni:
120*80*76 cm

Prezzo promo ~~Prezzo promo~~

€155

€67

ORDINE
MIN 2 PZ

Piano rovere / gambe nere : 5782





Tavoli in vetro fissi

BENNY

Questo tavolo presenta un design minimalista e moderno. Piano in vetro temperato bianco, che dona luminosità e leggerezza visiva. Quattro gambe angolari a sezione quadrata, in metallo, che garantiscono solidità e stabilità

Posti a sedere 6.

Prezzo promo

Dimensioni:
140*90*75 (cm)

€90

ALTRI COLORI DISPONIBILI:

Piano vetro / gambe bianche : 5850



Piano vetro / gambe silver : 9078





SUNNY

Tavolo quadrato in metallo, con particolare gamba centrale. Questo tavolo si adatta perfettamente a diversi stili di ambienti.

Posti a sedere da 2 a 4 posti.

Dimensioni:
70*70*75 (cm)

Prezzo promo

€62

Bianco:0376



 Tavoli contract
BARRY

Tavolo 80x80 cm dal design essenziale e contemporaneo.

Piano ovale con angoli arrotondati in rovere, dall'aspetto caldo e pulito. Struttura centrale a colonna singola in metallo verniciato bianco, che garantisce stabilità visiva e funzionale. Base ovale a terra, sempre in metallo bianco, sottile ma solida. Posti a sedere 4.

Dimensioni:
Ø80*H75 (cm)

Prezzo promo

€90

Rovere bianco: 9799



FUTURE

Tavolo tondo realizzato interamente in polipropilene con fori sul piano, perfetto per ambienti esterni.

IL TAVOLO PRESENTA SUL PIANO DEI PICCOLI FORI.

Posti a sedere 3.

Dimensioni:
Ø60*H75 (cm)

Prezzo promo

€50

Bianco : 6598





Verde : 1793

PIVOT

Tavolo in lamiera galvanizzata

Dimensioni:
60X60H75(cm)
80X80H75(cm) Bianco

Prezzo promo

€112

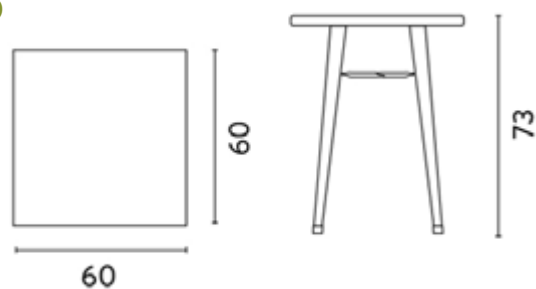

Bianco 80x80: 7591



Piombo:1794



Avorio:1794



IMBOTTITI

Collection





Velluto ruggine ossidato:9030





Poltrone imbottite

TALLIN *New!!!*

Poltrona dal design contemporaneo con seduta imbottita e forme avvolgenti, pensata per garantire comfort ed eleganza. Lo schienale leggermente inclinato si integra con i braccioli creando una linea continua e armoniosa, mentre il cuscino della seduta aggiunge morbidezza e accoglienza, gambe in metallo nere.

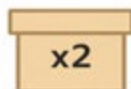

Prezzo promo

€54

Velluto old green: 7579



Velluto lamè tabacco: 7333





Ruggine:9580



Poltrone imbottite

MONICA *New!!!*

Poltrona da pranzo dal design avvolgente e contemporaneo, caratterizzata da una struttura completamente imbottita con volumi pieni e continui. Lo schienale curvo integra i braccioli in un unico elemento fluido, offrendo comfort e sostegno. La seduta è ampia e accogliente, sostenuta da gambe integrate nella struttura che conferiscono solidità e un'estetica monolitica

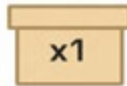

Dimensioni:
67*60*76

Prezzo promo

€105

Verde:9573





Poltrone imbottite

ARTEMISIA

Poltrona da pranzo dalle linee sofisticate,
Il sedile e lo schienale sono rivestiti in un tessuto.
La struttura della sedia è in metallo nero.

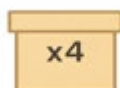

Dimensioni:
52*57*81 (cm)

Prezzo promo

€65

Prezzo promo

€52

ORDINE MIN
12 PZ

blu / gambe nere: 7258



verde/ gambe nere: 7272



verde/ gambe nere: 7272



Tortora: 7265



ARTEMISIA GOLD

Poltrona da pranzo dalle linee sofisticate, il sedile e lo schienale sono rivestiti in un tessuto. La struttura della sedia è in metallo dorato con una finitura lucida.

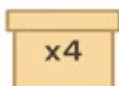

Dimensioni:
52*57*81 (cm)

Prezzo promo

€72

Prezzo promo

€59 ORDINE MIN
8 PZ

ruggine/ gambe oro: 7319



Verde/gambe oro: 7296



Tortora/ gambe oro: 7265





IRIDE *New!!!*

Poltrona imbottita caratterizzata da una seduta ampia e confortevole con schienale avvolgente leggermente inclinato. Il rivestimento in tessuto dalla trama materica dona profondità visiva e una sensazione tattile accogliente, mentre l'imbottitura equilibrata garantisce comfort senza appesantire il volume. La struttura è sostenuta da quattro gambe sottili in metallo verniciato nero, slanciate e leggere, che conferiscono stabilità e un aspetto moderno e raffinato.

Il "tessuto Aragon" non ha un'unica classificazione univoca, ma identifica tessuti di arredamento idrorepellenti, resistenti all'usura e dotati di tecnologie che impediscono l'assorbimento dei liquidi, rendendoli facili da pulire e ideali per divani e poltrone. La sua composizione esatta varia a seconda del produttore, ma è spesso caratterizzato da fili di contrasto e può includere finiture anti-macchia e resistenza alla luce.

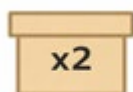

Dimensioni:
56*56.5*94

Prezzo promo

€43

Verde:9191



Salmon:6497





Poltrone imbottite

LUNIA *New!!!*

Poltrona dal design moderno e avvolgente, caratterizzata da una seduta imbottita ampia e confortevole e da uno schienale continuo che integra i braccioli in un'unica forma morbida ed ergonomica.

La struttura è sostenuta da quattro gambe sottili in metallo, leggermente inclinate, che conferiscono leggerezza visiva e stabilità.

Il "tessuto Aragon" non ha un'unica classificazione univoca, ma identifica tessuti di arredamento idrorepellenti, resistenti all'usura e dotati di tecnologie che impediscono l'assorbimento dei liquidi, rendendoli facili da pulire e ideali per divani e poltrone. La sua composizione esatta varia a seconda del produttore, ma è spesso caratterizzato da fili di contrasto e può includere finiture anti-macchia e resistenza alla luce.

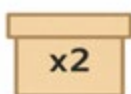

Dimensioni:
52*60*78

Prezzo promo

€68

Prezzo promo

€47 ORDINE MIN
8 PZ

Grigio/ gambe nere: 9610



ruggine / gambe nere: 9597



Cenere/ gambe nere: 6147



Poltrone imbottite

BRIGITTE

Poltrona da pranzo dalle linee sofisticate, lo schienale e il sedile sono realizzati in resistente multistrato con imbottitura in poliuretano espanso per un maggiore comfort e rivestiti in piacevole tessuto di poliestere. Le gambe e il telaio sono realizzati in tubo di ferro



Dimensioni:
55*56*78 (cm)

Prezzo promo

€63

Prezzo promo

€45 ORDINE MIN
12 PZ

Verde: 7401

Ruggine: 6123



© design registrato



Bouclè verde/ gambe nere: 0916



Poltrone imbottite

MEGAN

La poltrona linee pulite e forme arrotondate. Lo schienale alto e curvo, le gambe sottili in metallo nero contrastano con la morbidezza del rivestimento in tessuto bouclè.

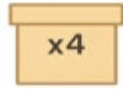

Dimensioni:
59*58*77.5 (cm)

Prezzo promo Prezzo promo

€62

€47 ORDINE MIN
12 PZ

Bouclè corda\gambe nere: 0930



© design registrato





Sedute imbottite

POINT

Sedia rivestita in velluto con schienale alto con motivo (chevron), gambe in metallo nere.

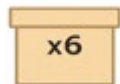

Dimensioni:
42X42XH89 HS49

Prezzo promo **Prezzo promo**

€36

€20 ordine
min 48 pz

Velluto blu:8644



 Sedute imbottite

KAREN

La sedia è realizzata in tessuto grigio con un dettaglio unico sullo schienale e gambe nere in metallo.



Dimensioni:
56X44X86.5 cm

Prezzo promo

€47

Prezzo promo

€28

ordine
min 24 pz

Tessuto cenere:5799

Tessuto tortora:5775





Sedute imbottite

TAMARA

La sedia è realizzata in tessuto o velluto con uno schienale arrotondato, rombi sul retro dello schienale e gambe in metallo nere. Il design è elegante e raffinato, e la sedia è perfetta per un ambiente moderno e sofisticato. La sedia è ideale per la sala da pranzo, lo studio o la camera da letto.

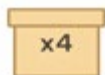

Dimensioni:
45*49*H85 HS 48 (cm)

Prezzo promo **€47**
Prezzo promo ordine min 24pz **€26**

Velluto cipria:8958



Tessuto verde inglese:6480



Tessuto Aragon blu:8972





Sedute imbottite

ARCA

Sedia in velluto, il sedile e lo schienale sono trapuntati con le gambe della sedia sono in metallo nere.

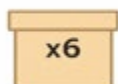

Dimensioni:
42X42XH89 HS49

Prezzo promo **€33** Prezzo promo ordine min 48pz **€22**

Tortora:9139



Senape:9153



Ruggine:9177



Petrolio:9160





Tessuto bordeaux:6031

Tessuto grigio:6550

Tessuto verde:5751



Sedute imbottite

DEDIS

Sedia impilabile con alto schienale imbottito, struttura in metallo tubolare con imbottitura in poliuretano, interamente rivestita in tessuto mozart o tessuto.



Dimensioni:
*44*98 HS 46 (cm)

Prezzo promo Prezzo promo

€54

€32 ordine
min 12pz

Mozart fango :1432



Mozart grigio:1463



Mozart tortora :5560



 Sedute imbottite

FRIDA

Lo schienale è composto da una serie di imbottiture verticali a sezione arrotondata che si aprono a ventaglio. È completamente rivestita in tessuto Aragon*. La seduta è ampia e imbottita, mentre le gambe, sottili e inclinate, sono in metallo nero opaco con terminali dorati.

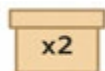

Dimensioni: 56X50X80

Prezzo promo

€47





Sedute imbottite

DANI

Le gambe sono rivestite in velluto sottili e slanciate la seduta che lo schienale sono imbottiti e rivestiti in velluto millerighe.



Dimensioni:
46*50*89 (cm)

Prezzo promo

€54

Prezzo promo

€22 ordine
min 24 pz

Millerighe tortora:5539



Tessuto porpora\ vinaccio



velluto verde / gambe nere :6312



Sedute imbottite

NEW LENA TESSUTO

La sedia è realizzata in tessuto CANVAS che conferisce alla sedia un aspetto elegante e raffinato. La seduta è imbottita e presenta un motivo a rombi, che aggiunge un tocco di originalità al design. Le gambe sono sottili e slanciate, in metallo nero, che conferiscono alla sedia un aspetto leggero e moderno.

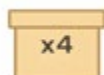

Dimensioni: 44*52*85

Prezzo promo

€33

Prezzo promo

€20

ordine
min 24 pz

Tessuto cenere:8639



Tessuto petrolio :8684



Tessuto porpora|vinaccio





velluto grigio/ gambe oro :5881



Sedute imbottite

NEW LENA GOLD

La sedia è realizzata in velluto, un tessuto morbido e lussuoso che conferisce alla sedia un aspetto elegante e raffinato. La seduta è imbottita e presenta un motivo a rombi, che aggiunge un tocco di originalità al design. Le gambe sono sottili e slanciate oro, che conferiscono alla sedia un aspetto elegante.

velluto nero/ gambe oro :8288

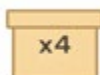

Dimensioni: 44*52*85

Prezzo promo

€30

velluto fango / gambe oro :5874



velluto verde / gambe oro : 8057





Grigio

VIRGINIA

La sedia presenta una struttura elegante e contemporanea. Le gambe sono sottili e affusolate, realizzate in metallo nero, che conferiscono un aspetto leggero e slanciato la seduta e lo schienale sono imbottiti e rivestiti in un tessuto Aragon*, resistente e facile da pulire, ideale per un uso quotidiano.

Il "tessuto Aragon" non ha un'unica classificazione univoca, ma identifica tessuti di arredamento idrorepellenti, resistenti all'usura e dotati di tecnologie che impediscono l'assorbimento dei liquidi, rendendoli facili da pulire e ideali per divani e poltrone. La sua composizione esatta varia a seconda del produttore, ma è spesso caratterizzato da fili di contrasto e può includere finiture anti-macchia e resistenza alla luce.

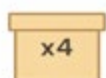

Dimensioni:
50*50*90 (cm)

Prezzo promo Prezzo promo

€59

€43 ordine
min 24 pz

Petrolio



verde:7463



Ruggine:9061



© design registrato



Sedute imbottite QUEEN

La sedia presenta una struttura metallica in alluminio dalle linee semplici e slanciate, Sia la seduta che lo schienale sono imbottiti e rivestiti in PU (tessuto non tessuto). Lo schienale alto e leggermente curvo offre un buon supporto alla schiena, mentre la seduta è ergonomica e confortevole.

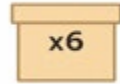

Dimensioni: 40*47*96 cm

Prezzo promo

€25

Prezzo promo

€13 ordine
min 48 pz
assortite

nera / gambe nere: 5362



bianca/ gambe all:0022





PEPITA

Sedia con struttura in legno e seduta in bambù, lo schienale è caratterizzato da un design a "X", un elemento classico che richiama lo stile delle sedie da bistrot. Questa forma offre un buon supporto alla schiena.



Dimensioni:
48X52X89 (cm)



Prezzo promo

€65

Prezzo promo

€52

ordine
min 12 pz

Bianco/bambù: 6673

Nero/bambù: 6680



POLICARBONATO

Collection









Sedie in policarbonato

SPARTA *New!!!*

Sedia monoscocca in materiale plastico trasparente, dal design essenziale e contemporaneo. La struttura è definita da linee morbide e continue, con seduta leggermente sagomata e schienale curvo che assicura comfort e sostegno. Le quattro gambe, sottili e affusolate, si integrano armoniosamente nella scocca, mantenendo un'estetica leggera e visivamente pulita. La finitura completamente trasparente valorizza le forme e rende la sedia versatile, ideale per ambienti moderni sia residenziali che contract.



Dimensioni: 51X46X83

Prezzo promo **Prezzo promo**

€40

€30 ordine
min 12 pz



Trasparente:9788





Sedie in metacrilato

ZARA *New!!!*

Sedia in policarbonato trasparente dal forte richiamo barocco, caratterizzata da una silhouette elegante e scenografica.

Lo schienale è alto e sagomato, arricchito da decori ornamentali e motivi curvilinei che ne esaltano il gusto classico, reinterpretato in chiave contemporanea grazie alla totale trasparenza del materiale.

La seduta è ampia e leggermente sagomata, con profili morbidi che garantiscono comfort visivo e funzionale.

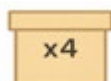

Dimensioni:
53X55X99.5



Prezzo promo

€43



Trasparente: 9801



Poltrone in metacrilato

ZARA *New!!!*

Sedia con braccioli in policarbonato trasparente, la struttura monoblocco è realizzata in materiale plastico trasparente ad alta resistenza, con finitura cristallina che valorizza le forme decorative. Lo schienale è sagomato e impreziosito da motivi barocchi in rilievo nella parte superiore, mentre la seduta è ampia, liscia e leggermente sagomata per garantire comfort. Le gambe sono slanciate e curvate, con dettagli decorativi integrati, conferendo eleganza e leggerezza visiva.

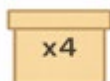

Dimensioni:
58X55X99.5



Prezzo promo

€54

Trasparente:9795





Sedie in policarbonato

GAETA

Sedia trasparente in policarbonato, dal design iconico ed elegante.

La struttura è monoscocca, completamente trasparente, con schienale ovale morbido e avvolgente che richiama uno stile classico reinterpretato in chiave moderna.

La seduta è liscia, leggermente sagomata per garantire comfort, mentre le quattro gambe affusolate e leggermente arcuate conferiscono slancio e stabilità. La trasparenza del materiale valorizza le linee fluide e rende la sedia visivamente leggera, ideale per ambienti contemporanei, contract e residenziali.

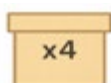

Dimensioni: 40*55*90



Prezzo promo

€33



Trasparente:6688





Poltrone in metacrilato

ATENE *New!!!*

Sedia in policarbonato trasparente d'ispirazione classica, caratterizzata da un design elegante e senza tempo.

Lo schienale ovale, incorniciato da un delicato motivo a perline, conferisce raffinatezza e leggerezza visiva.

La seduta è ampia e leggermente arrotondata, con profili puliti che mantengono un'estetica armoniosa e funzionale.

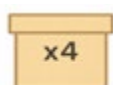

Dimensioni: 53X55X99.5

Prezzo promo

€36



Trasparente:9825







Poltrone in metacrilato

ATENE *New!!!*

Poltrona monoblocco in policarbonato trasparente, dal design classico rivisitato in chiave contemporanea. Schienale ovale con cornice perimetrale lavorata a rilievo, braccioli curvi e integrati nella struttura che accompagnano la seduta in modo fluido. Seduta ampia e liscia, con spessori pieni che enfatizzano la solidità del materiale pur mantenendo un'estetica leggera.



x4

Dimensioni: 58*55*99.5



Prezzo promo

€47



Trasparente:9818



POLIPROPILENE

Collection





Promo White

CORDOBA

Bianca:9568



* ordine minimo una pedana
monocolore (30 pz)

Prezzo promo

€20

BRAGA

Bianca:1562



* ordine minimo una pedana
monocolore (12 pz)

Prezzo promo

€22

ZANTE

Bianca:6909



* ordine minimo una pedana
monocolore (26 pz)

Prezzo promo

€27

SIBARI

Bianca:6947



* ordine minimo una pedana
monocolore (26pz)

Prezzo promo

€22

ELVIRA

Bianca:6527



* ordine minimo una pedana
monocolore (24\28 pz)

Prezzo promo

€15

CHAPEAU

Bianca:0992



* ordine minimo una pedana
monocolore (36 pz)

Prezzo promo

€13

CROSS

Bianca:9490



* ordine minimo una pe-
dana monocolore (22 pz)

Prezzo promo

€22



Sedie in polipropilene

ARIEL

La sedia è realizzata interamente in polipropilene, un materiale leggero, resistente e facile da pulire. Lo schienale è caratterizzato da un motivo traforato che conferisce alla sedia leggerezza visiva e favorisce la traspirazione.

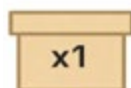

Dimensioni:
39.5X40X78 cm



Prezzo promo

€22

Prezzo promo

€17 ordine
min 36pz



Salvia:616



© design registrato



Sedie in polipropilene

CHAPEAU

Sedia realizzata interamente in polipropilene.

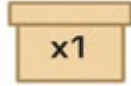

Dimensioni:
38*39*78 HS43 cm



Prezzo promo

€22

Prezzo promo

€14

ordine
min 36pz

Antracite:1005



Tortora:1012



Tortora:9667





Sedie in polipropilene

CORDOBA

Sedia in polipropilene, caratterizzata da un design minimalista e contemporaneo, caratterizzato da linee pulite e forme squadrate.

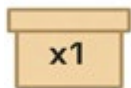

Dimensioni:
54*44*77 (cm)



Prezzo promo

€36

Prezzo promo

€25

ordine
min 30pz

Rosso mattone:9537



Carta da zucchero:9551



Senape:9544



Antracite:8217



Bronzo:7098





Sedie in polipropilene

BELLA

La sedia si presenta con una silhouette semplice ma decisa, un'icona di minimalismo funzionale. La seduta, ampia e leggermente concava, promette comfort senza fronzoli, invitando a una pausa di relax.

Lo schienale, di altezza media, è caratterizzato da una sottile fessura orizzontale, un dettaglio che aggiunge

un tocco di originalità senza compromettere la pulizia delle linee.

Realizzata in polipropilene perfetta per ambienti outdoor.

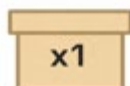

Dimensioni:
48 x 51.5 x 81



Prezzo promo

€40

Prezzo promo

€25 ordine
min 34pz

Verde:7135



Acero:7104



© design registrato





Sedie in polipropilene

ZANTE

Sedia in polipropilene, caratterizzata da un design minimalista e contemporaneo, caratterizzato da linee pulite e forme squadrate, perfetta per arredare ambienti esterni

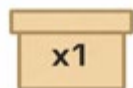

Dimensioni:
56X52X82 HS 46

Prezzo promo

€45

Prezzo promo

€33 ordine
min 26pz



Terracotta:6886



Verde inglese:6879





Ambra:6930



Sedie in polipropilene

SIBARI

Sedia in polipropilene, caratterizzata da un design minimalista e particolare, la seduta e lo schienale sono arricchiti da dei fori traspiranti.

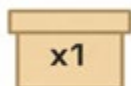

Dimensioni:
56X52X82 HS 46



Prezzo promo

€45

Prezzo promo

€26 ordine
min26pz

Terracotta:6923



Verde inglese:6916





Bianca:6954



Poltrone in polipropilene

SIBARI

Poltrona in polipropilene, caratterizzata da un design particolare, caratterizzato da linee pulite e forme squadrate. la seduta e lo schienale sono arricchiti da dei fori traspiranti.

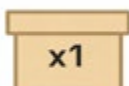

Dimensioni:
55*55*79 HS 46



Prezzo promo

€28

Verde inglese: 7555



Mattone: 7548



Ambra: 6961





Verde inglese:6978



Sedie in polipropilene

ITACA

Sedia in polipropilene, caratterizzata da un design semplice e linee fluide, lo schienale e la seduta sono arricchiti da aperture verticali.

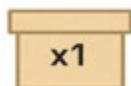

Dimensioni:
56X52X82 HS 46



Prezzo promo

€45

Prezzo promo

€33 ordine
min 31pz

Ambra:6992



Terracotta:6985





Ambra:7026



Poltrone in polipropilene

ITACA

Poltrona in polipropilene, caratterizzata da un design semplice e linee fluide, lo schienale e la seduta sono arricchiti da aperture verticali.

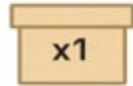

Dimensioni:
55*57*81 HS45



Prezzo promo

€36

Mattone: 7029



Verde inglese: 7012





Sedie in polipropilene

CROSS

Sedia in polipropilene con design classico e senza tempo, caratterizzato da linee semplici e pulite.

La struttura è composta da una seduta e uno schienale in polipropilene, con un motivo a croce che conferisce alla sedia un tocco di eleganza.

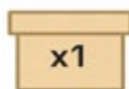

Dimensioni:
90x43x43 (cm)



Prezzo promo

€28

Prezzo promo

€22 ordine
min 22 pz

Tortora:1500



Azzurra:8064



Nera:9506





Sedie in polipropilene

YARD

Sedia in resina dalle linee pulite e minimal garantisce leggerezza e maneggevolezza.

Dimensioni:

53.5*60*H89 HS46 cm

Prezzo promo

€50



Antracite: 6669





Tortora:1579

Nero:9940



Sedie in polipropilene

BRAGA

La sedia è realizzata interamente in polipropilene , un materiale resistente agli agenti atmosferici e facile da pulire.

La seduta e lo schienale sono formati da un intreccio che crea un motivo a rete, conferendo alla sedia un aspetto leggero e arioso. La sedia è impilabile, il che la rende pratica da riporre quando non è in uso.

Braga è adatta sia per uso domestico che commerciale.

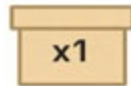

Dimensioni:
60x50x82(cm)



Prezzo promo

€36

Prezzo promo

€28

ordine

min 12pz assortiti

Mattone:9575



Verde oliva:1470



Carta da zucchero:6558



Senape:1586



© design registrato

 Sedie in metallo

INDUSTRIAL

Sedie stile industriale vintage realizzate in metallo verniciato a polvere, robuste e resistenti.

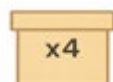

Dimensioni: 40*50*85 cm

Prezzo promo

€28



Bianca:6824



COVER SEDIE

Cover per pila di quattro sedie – misura 66 x 66 x h. 120 cm – poliestere impermeabile ed extra resistente – con prese d'aria

Prezzo promo

€33



Grigio: ART01546



Poltrone in metallo

RIMINI

La sedia è un modello bistrot contemporaneo con struttura snella in metallo e seduta + schienale intrecciati.

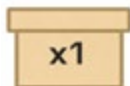

Dimensioni:
56*59*78 HS45



Prezzo promo

€62

Verde:1552



Corda\ antracite:1681



Corda\ bianco:1680





Bianca: 7142



Poltrone in polipropilene

MAIORCA

La struttura è composta da gambe e braccioli in polipropilene, che conferiscono alla sedia un aspetto solido e resistente. Le linee sono semplici e pulite, con forme curve che la rendono ergonomica e confortevole.

Lo schienale è la caratteristica distintiva di questa sedia. È realizzato con un intreccio di corde **NATURALI**, spesso di colore naturale o chiaro, che crea un effetto visivo caldo e accogliente.

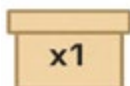

Dimensioni: 56x55x78 cm

Prezzo promo

€40



Antracite: 7159



© design registrato

SGABELLI

Collection







Tortora:6154



Sgabelli imbottiti

BRIGITTE

Linee moderne e accoglienti si fondono nello sgabello imbottito, rivestito in tessuto perfetto per ambienti cucina o zona snack dal gusto contemporaneo. La struttura slanciata in metallo verniciato nero opaco garantisce stabilità e leggerezza visiva, mentre il poggiatesta integrato assicura comfort anche durante le sedute prolungate.

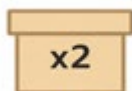

Dimensioni:

50x50x110 HS 75

50x50x110 HS 65

Prezzo promo

€67

Verde:7500



Cenere:6178



Ruggine:6161



 Sgabelli imbottiti

NEW TAMARA

Lo sgabello è realizzato in tessuto con uno schienale arrotondato e gambe in metallo nere. Il design è elegante e raffinato, perfetto per un ambiente moderno e sofisticato.

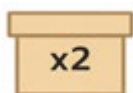

Dimensioni:

42x40x108 **HS 75**

42x40x108 **HS 65**

Prezzo promo

€54

Tessuto verde



NEW LENA

La seduta è imbottita e rivestita in tessuto con un motivo a rombi sullo schienale, gambe in metallo nere.

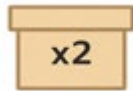

Dimensioni:

44*53*112 HS 75 cm

44*53*112 HS 65 cm

Prezzo promo

€54

Cenere:8813



Tortora:8806



Corda:8790



Fango:8868



 Sgabelli imbottiti

ARTEMISIA GOLD

Lo sgabello è realizzato in tessuto con uno schienale arrotondato e gambe cromate oro . Il design è elegante e raffinato, perfetto per un ambiente moderno e sofisticato.

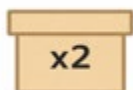

Dimensioni:

52*57*81 HS 75

52*57*81 HS 65

Prezzo promo

€73



Ruggine:9054



Sgabelli imbottiti

ARTEMISIA

Lo sgabello è realizzato in tessuto con uno schienale arrotondato e gambe in metallo nere. Il design è elegante e raffinato, perfetto per un ambiente moderno e sofisticato.

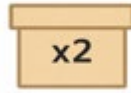

Dimensioni:

52*57*81 HS 75

52*57*81 HS 65

Prezzo promo

€70

Verde:9016



Blu:9009



Ruggine:9047







Sgabelli imbottiti

MEGAN

Lo sgabello è realizzato in tessuto bouclè , un materiale morbido e lussuoso che conferisce allo sgabello un aspetto elegante e raffinato. Lo schienale è curvo e avvolgente, mentre la seduta è ampia e confortevole. Le gambe sono sottili e slanciate, in metallo nero, che conferiscono allo sgabello un aspetto leggero e moderno.

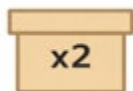

Dimensioni:

53x45x86 HS: 75

53x45x86HS: 65

Prezzo promo

€70

Verde:0961





Bronzo: 7067



Sgabelli Polipropilene

BELLA

Sgabello realizzato interamente in polipropilene.



Dimensioni:
53*54*102 HS75

Prezzo promo

€47



Tortora: 7050



Bianco: 7074



Antracite: 8224



© design registrato



Bianco:9926

CROSS

Sgabello in polipropilene, schienale a x seduta ampia e sagomata.

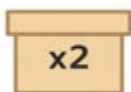

Dimensioni:
48*49*H102 HS74



Prezzo promo

€43

Antracite:9919



Tortora:8071



BRAGA

Sgabello realizzato interamente in polipropilene, La seduta e lo schienale sono integrati in un unico pezzo formando una superficie traforata.

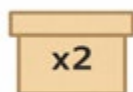

Dimensioni:
45*51*H106 HS75(cm)

Prezzo promo

€47



Bianco:9964



ZANTE

Sgabello realizzato interamente in polipropilene, La seduta e lo schienale sono integrati in un unico pezzo

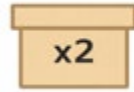

Dimensioni:
49*55*104 HS 75

Prezzo promo

€81



Ambra:6855





 Sgabelli in metallo

INDUSTRIAL

Sgabello stile industriale vintage realizzato in metallo verniciato a polvere, dalla a una forma semplice e lineare , Il design neutro e le dimensioni standard lo rendono adatto a diversi spazi e stili d'arredo.

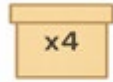

Dimensioni: 30*30*76 cm

Prezzo promo

€40

Bianco:6848



POLTRONE RELAX

Collection







ARLETTE A IGNIFUGA

Caratteristiche principali:

Poltrona relax con meccanismo reclinabile manuale tramite leva, la poltrona presenta un design elegante e senza tempo, caratterizzato da linee morbide e dettagli curati. Il rivestimento è in tessuto Mozart ignifugo. Lo schienale è alto e avvolgente, con una forma leggermente arrotondata che ricorda le poltrone classiche. Inoltre la poltrona è dotata di alette laterali che offrono un ottimo sostegno per la testa e il collo.

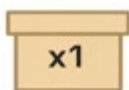

Dimensioni:

74*74*109

Prezzo promo

€269

Prezzo promo

€185 ordine
min 6 pz

Mozart grigia cemento:1845





 Poltrone relax

GIUDITTA A

Caratteristiche principali:

- Meccanismo: reclinabile manuale con leva laterale
- Rivestimento: tessuto di alta qualità
- Schienale alto e curvo per supporto ottimale
- Seduta imbottita, ampia e confortevole
- Braccioli imbottiti dalla forma arrotondata

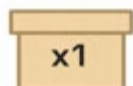

Dimensioni:

80*88*102

Prezzo promo

€195

Prezzo promo

€162 ordine
min 6 pz



Safari:6369



CARLOTTA A

Caratteristiche principali:

- Meccanismo: reclinabile manuale con leva laterale
- Rivestimento: tessuto di alta qualità
- Schienale alto e curvo per supporto ottimale
- Seduta imbottita, ampia e confortevole
- Braccioli imbottiti dalla forma arrotondata

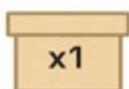

Dimensioni:

70*87*104

Prezzo promo

€180

Prezzo promo

€140 ordine
min 6 pz



Safari:8943



 Poltrone relax

CARLOTTA D LIFT

Caratteristiche principali:

- Meccanismo: elettrico recliner + alzapersona
- Comandi: pulsantiera laterale intuitiva
- Funzione USB: ricarica dispositivi mobili integrata
- Comfort: imbottitura ergonomica e schienale alto

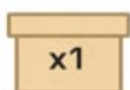

Dimensioni:

68*87*104

Prezzo promo

€257

Prezzo promo

€200

ordine
min 6 pz



Corda: 6338

POLTRONE & DIVANI *Collection*





Super Promo

Poltrone

tris €347

tris €279



SET CHALEN 3+2 POSTI

Set divano 3+2 posti con 4 recliner totali manuale è pensato per trasformare ogni momento di relax in un'esperienza unica. Disponibile in due tonalità: taupe e verde britannico. Realizzati in tessuto Benidorm Cat D, un tessuto pesante e robusto composto da cotone e poliestere, con trama grossolana e resistente.

Taupe



Tessuto Taupe:9276

Verde
Britannico



Tessuto britannico:9283

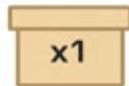

Dimensioni:
189*92*100+138*92*100

Prezzo promo

€615



Tessuto britannico:9511



SET CHALEN 3+2 POSTI

Set divano 3+2 posti con 4 recliner totali elettrico con pulsantiera. Pensato per trasformare ogni momento di relax in un'esperienza unica. Disponibile in due tonalità: taupe e verde britannico. Realizzati in tessuto Benidorm Cat D, un tessuto pesante e robusto composto da cotone e poliestere, con trama grossolana e resistente.

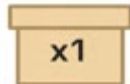

Dimensioni:
189*92*100+138*92*100

Prezzo promo

€863 ELETTRICO



Taupe



Verde
Britannico



Tessuto Taupe:9504





MARILYN

La poltrona presenta un design che unisce elementi classici e moderni.

Il rivestimento è in tessuto a pied de poule.

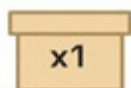

Dimensioni:
78*86*H84

Prezzo promo ~~Prezzo promo~~

€269

€195 ordine
min 2 PZ

black and white:9771



© design registrato



MILO

Poltrona in velluto dal design compatto e avvolgente, caratterizzata da una silhouette morbida e continua che crea un effetto accogliente ed elegante. Lo schienale curvo e i braccioli integrati formano un unico volume armonioso, studiato per offrire comfort e sostegno ottimale.

La seduta imbottita garantisce una piacevole sensazione di relax, mentre le linee pulite e la cura dei dettagli sartoriali valorizzano l'estetica contemporanea del prodotto.

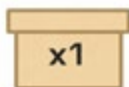

Dimensioni:
68x64x73 cm

Prezzo promo

€145

Prezzo promo

€100 ordine
min 2 PZ

Velluto Ruggine:9559





TEDDY

La poltrona presenta un design unico e caratteristico, con forme morbide e arrotondate che invitano al relax. Il contrasto tra la struttura in metallo nero e il rivestimento morbido in tessuto bouclè crea un effetto visivo interessante e accattivante.

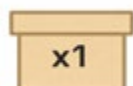

Dimensioni: 85*83*71.5 cm

Prezzo promo ~~Prezzo promo~~

€207

€150 ORDINE MIN
2 PZ

Grigio:7948



© design registrato

Tortora:6642



NIKOS

Il rivestimento è in tessuto moztart **SFODERABILE**, la seduta e lo schienale sono imbottiti e presentano delle cuciture verticali, gambe in metallo

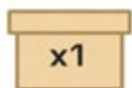

Dimensioni:
71X77X83 cm

Prezzo promo Prezzo promo

€108

€67 ordine
min 2 pz

Rame:6635





FRIDA

La poltrona presenta un design sofisticato e accogliente, caratterizzato da linee morbide e sinuose che richiamano la forma di un fiore. Il rivestimento in velluto o tessuto bouclè che conferisce alla poltrona un aspetto lussuoso e contemporaneo. La struttura della poltrona è probabilmente in metallo cromato oro, rivestita con imbottitura in schiuma per garantire un comfort ottimale.

*Completa di cuscino

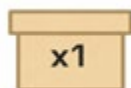

Dimensioni:
82*79*H79

Prezzo promo **Prezzo promo**

€123

€99

ordine
min 6 pz

Senape:0084



Ruggine:0091



Bouclè Panna: 8004



Nero:0060





Bouclè Panna:8134



DIVANO FRIDA

Elegante e unico, il divano è l'eyecatcher ottimo per living, soggiorni, stanze da letto o locali.

Il suo design rievoca i divani dell'art nouveau, il rivestimento in bouclè o è messo in risalto dal colore ottone delle gambe, piccole, ma resistenti, sottili e discrete.

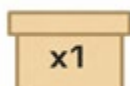

Dimensioni:
136*79*79

Prezzo promo

€213

Senape:0213



Ruggine:0206



**WORK
HARD**
& BE NICE
TO PEOPLE

UFFICIO

Collection





Super Promo

Sedie d'ufficio

1 tris €195

3 tris €167

totale 9 pz

Bianco:7931



Bianco:7948



MITO PRESIDENZ

La poltrona presenta una struttura in metallo cromato, Lo schienale alto è caratterizzato da un design avvolgente e diviso in più cuscini imbottiti in PU rigenerato tessuto non tessuto.

La seduta è ampia e imbottita, garantendo un comfort prolungato anche durante lunghe ore di lavoro.

La base è dotata di cinque ruote per una facile mobilità.

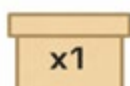

Dimensioni:
07.5-117.5*61*56 (cm)

Prezzo promo **Prezzo promo**

€280

1 SET
(4 PZ 1X
COLORE)

€223

ORDINE MIN 3 SET
(1 X COLORE)

*Super
Promo*

Bianco:7955

Nero:8192

Grigio:4930

Tortora:4947







Poltrona da cameretta

SAMIRA

La Poltrona presenta una struttura ergonomica e avvolgente, realizzata in polipropilene.

Lo schienale è caratterizzato da un design particolare, con fori a forma di impronte di zampe che conferiscono un tocco giocoso e originale.

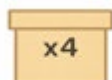

Dimensioni:
49*57*83/95 (cm)



Prezzo promo

Prezzo promo

€33

ordine

4 pz x colore

€537

ordine

min 24 pz

(4 x colore)

Grigio:6671



Ambra:6640



Tortora:6664



Bianca:6657



Blu:8088



Petrolio:8095



© design registrato

GAMING OMEGA

Lo schienale alto è caratterizzato da un design avvolgente e sportivo, spesso con cuscini lombari e poggiatesta integrati per offrire un ottimo supporto alla zona lombare e cervicale, il rivestimento è in PU tessuto non tessuto. Inoltre la sedia è dotata di un poggiatesta ed è possibile reclinare lo schienale o regolarlo in altezza.

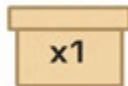

Dimensioni:
61x51x120/130 (cm)

Prezzo promo Prezzo promo

€64

€302 6 PZ

Rosso:6606

*Super
Promo*



Poltrone da ufficio GAMING ALFA

Lo schienale alto è caratterizzato da un design avvolgente e sportivo, spesso con cuscini lombari e

poggiatesta integrati per offrire un ottimo supporto alla zona lombare e cervicale, il rivestimento è in PU

tessuto non tessuto. Inoltre è possibile reclinare lo schienale o regolarlo in altezza.

Dimensioni:
65*62*105/110 (cm)

Prezzo promo Prezzo promo

€67

€ 50

ordine
min 8 pz
min 2 pz x colore

Blu:5447



Nero:5416



Bianca:5454



TAVOLINI

Collection







Bianco:8187

SET ALTEA

Entrambi i tavolini sono realizzati interamente in metallo, con una finitura nera opaca che conferisce un aspetto elegante e moderno. La forma è caratterizzata da linee semplici e geometriche. Entrambi i tavolini hanno un piano superiore rotondo e una base a forma di tronco di cono rovesciato. La differenza tra i due tavolini sta nelle dimensioni, con un tavolo più grande e uno più piccolo, creando un effetto visivo interessante.

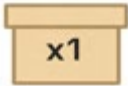

Dimensioni:

DIA 70*40+DIA 50*48 cm (nero)

DIA 50X48 CM + 70X38 CM (bianco)

Prezzo promo

€112 ordine
min 2 set



Nero:6253



SOLEIL

Il tavolino presenta una combinazione di materiali che conferiscono un aspetto elegante e contemporaneo:

Piano: Realizzato in marmo bianco, un materiale naturale caratterizzato da venature. La forma è rotonda, conferendo al tavolino un aspetto leggero ed equilibrato.

Base: Realizzata in metallo, verniciato di nero, per creare un contrasto visivo con il bianco del marmo. La base è composta da due parti: una parte superiore a forma di vaso o colonna, che sostiene il piano, e una base più ampia a forma di cono, che garantisce la stabilità.

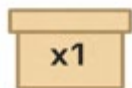

Dimensioni:
DIA50*63

Prezzo promo

€44 ordine
min 2 pz



Struttura nera/piano bianco con venature: 6260



RENEE'

Il tavolino presenta una combinazione di materiali:
Piano e ripiano inferiore: Realizzati in vetro temperato trasparente, offrono un aspetto elegante e moderno, oltre a una facile pulizia.

Gambe: Realizzate in legno laccato bianco o cemento, conferiscono un tocco di calore e contrasto al vetro. Le gambe sono spesso dotate di piedini in metallo cromato per una maggiore stabilità e un tocco di raffinatezza.

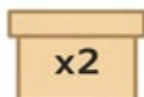

Dimensioni:
00*60*45 cm

Prezzo promo

€50

Prezzo promo

€41 ordine
min 6 pz



Bianco:1524



Cemento:6109

VERSUS

Il tavolino nella foto è un complemento d'arredo dal design moderno e minimalista, realizzato completamente in vetro curvato trasparente. La sua forma a "C" rovesciata lo rende estremamente funzionale: può essere utilizzato come tavolino da salotto, piano d'appoggio laterale per un divano o una poltrona, oppure anche come comodino.

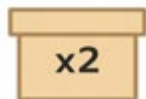

Dimensioni:
120*60*30

Prezzo promo

€ 123 ordine
min 2 pz

vetro:9210





CORINNE

Tavolino da salotto interamente realizzato in vetro curvato, dallo spessore robusto e resistente. La sua forma originale a profilo ondulato crea un design moderno e dinamico, pur mantenendo linee semplici ed eleganti. La trasparenza del vetro dona leggerezza visiva, rendendolo ideale per ambienti contemporanei e minimalisti, senza appesantire lo spazio. Perfetto come coffee table, si adatta facilmente a diversi stili d'arredo grazie alla sua versatilità e raffinatezza.

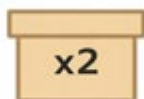

Dimensioni:
120*60*38 (cm)

Prezzo promo

€163 ordine
min 2 pz

vetro:9227



Tavolini HALL

Il tavolino nella foto è un complemento d'arredo dal design moderno e minimalista, realizzato completamente in vetro curvato trasparente. La sua forma a "C" rovesciata lo rende estremamente funzionale: può essere utilizzato come tavolino da salotto, piano d'appoggio laterale per un divano o una poltrona, oppure anche come comodino.

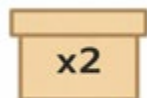

Dimensioni: 40*40*60

Prezzo promo

€ 67 ordine
min 2 pz

vetro:9197



BELLY

Il tavolino è realizzato principalmente in metallo. Il piano superiore è in metallo con una finitura dorata che gli conferisce un aspetto elegante e luminoso. La struttura portante, ovvero le gambe, è anch'essa in metallo, ma con una finitura nera che crea un interessante contrasto con il piano.

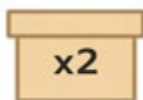

Dimensioni:
H48,5 Ø40 cm

Prezzo promo

€25 ordine
min 2 pz

Oro:2189





SET TAVOLINI CIRCLE

I tavolini presentano una combinazione di materiali:

Piano: Realizzato laminato, con una finitura rovere che conferisce un aspetto naturale e caldo.

Struttura: Realizzata in metallo laccato nero, con un design traforato che crea un motivo decorativo.

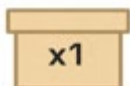

Dimensioni:

BIG: 40X45 SMALL 33.5X40 cm

Prezzo promo

€65 ordine
min 2 set

Nero:6710





LESHA

Tavolino realizzato in metallo, il piano superiore è di colore bianco legno decapato, mentre il corpo presenta una base chiara con un motivo dorato e rosa. Il motivo è traforato e simula una lavorazione artigianale in stile orientale o arabeggiate.

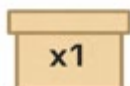

Dimensioni:
DIA:40X44

Prezzo promo

€40 ordine
min 2 set



Rosaloro:2165



SET TAVOLINI HEXAGON

Questo set di tavolini presenta una combinazione interessante di materiali:
Piano: Realizzato in laminato dalla forma esagonale. Struttura: Realizzata in metallo verniciato di nero. La struttura è composta da linee geometriche che si intersecano creando una forma tridimensionale.

I tavolini sono dimensioni diverse, creando un effetto visivo dinamico.

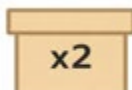

Dimensioni:

BIG: H41,5*P39*L45 SMALL: H39*P35*L40,5 cm

Prezzo promo

€52 ordine
min 2 set



Rovere:2080



MODAS

tavolino in metallo

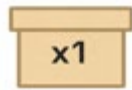

Dimensioni: 60x60 h30

Prezzo promo

€34

Nero:9577



Grigio:9560



Bianco:9553



 Tavolini

MODAS

tavolino in metallo

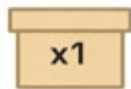

Dimensioni: 80x60 h30

Prezzo promo

€45

Nero:9607



Grigio:9591



SPECCHIERE *Collection*





MAGIK 120

Lo specchio ha una forma rettangolare allungata, ma con contorni irregolari e sinuosi che conferiscono alla cornice un aspetto scultoreo.

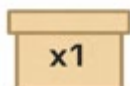

Dimensioni:
121x2,5x90 (cm)

Prezzo promo

€50 ordine
min 2 pz

Grigio:1045



Oro/Nero:1021



MAGIK 90

Lo specchio ha una forma rettangolare allungata, ma con contorni irregolari e sinuosi che conferiscono alla cornice un aspetto scultoreo.

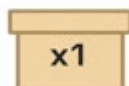

Dimensioni:
1x2,5x60 (cm)

Prezzo promo

€40 ordine
min 2 pz



Oro/Nero:0994



Grigio:1007



CONSOLLE *Collection*

TEKA

Elemento particolare è la struttura in metallo dorato, seppur dal design lineare presenta una decorazione, adiacente al piano in vetro temperato, che la rende unica e un eyecatcher ideale per arredare il proprio living, o sala da pranzo o salotto,

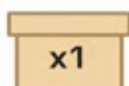

Dimensioni:
120*40*H75 (cm)

Prezzo promo

€157



Oro | Vetro: 0222

*TAVOLI
CONTRACT
Collection*





 Piani componibili

DIAMOND

Piano in microceramica da 12 mm

-80x80 (cm)

-70x70 (cm)



Nero\ con venature:7722

Grigio\ venature bianche:6444

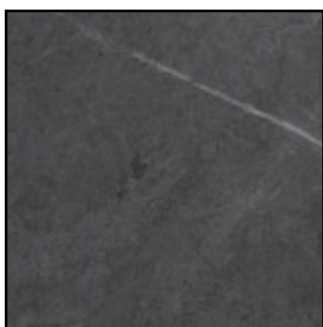

Calacatta beige:7807

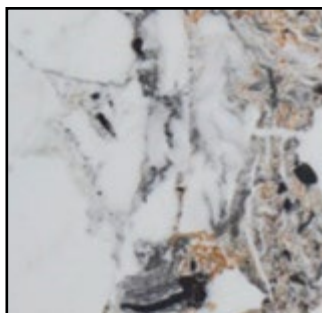

Bianco\ venature grigie:6437



Prezzo promo

€45

Prezzo promo

€32 ordine
min 26 piani

DIAMOND

Piano in microceramica da 12 mm tondo.

-ø60 (cm)

-ø65 (cm)

-ø70 (cm)

-ø75 (cm)

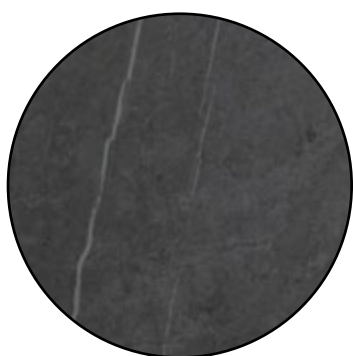

DIA 60 CM €50

DIA 65 CM €56

DIA 70 CM €62

DIA 75 CM €67



DIAMOND BORDO ORO

Piano in microceramica con bordo oro DA 30 mm
-70x70 (cm)
-80x80 (cm)



Nero\ con venature:6475



Prezzo promo

€67

Calacatta beige:6475

Piani componibili PIANO HPL

Piano in hpl, dotato di superfici resistenti, impermeabili e igieniche. La maggior parte delle macchie si rimuove con acqua e detersivi domestici non aggressivi.

Per una cura ottimale si consiglia una spugna morbida con sapone neutro o pulitori specifici per HPL.

-70x70 (cm)

-80x80 (cm)

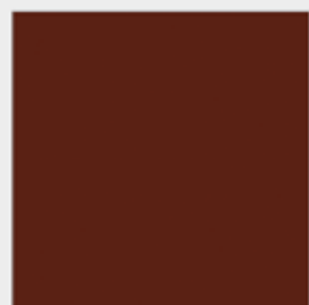

LAGOS

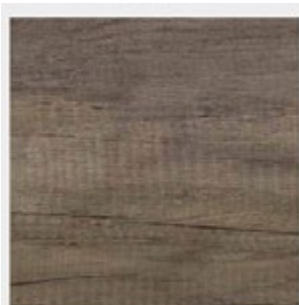

MAHEN

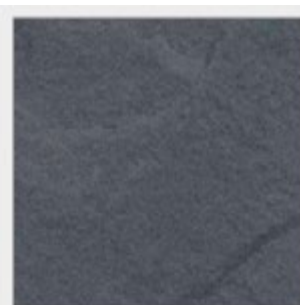

CEMENTO

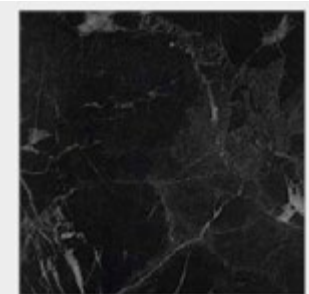

TAHE'



PIETRA



ARDESIA

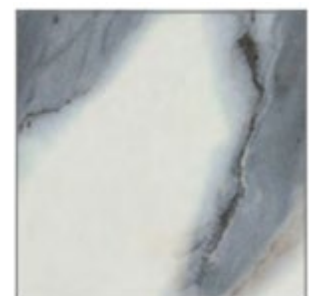

BALE'

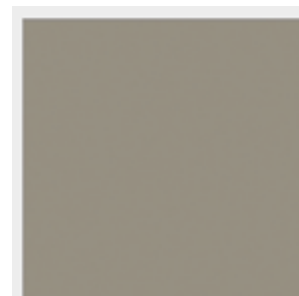

TAUPE

Prezzo promo

€67_{70X70}

€78_{80X80}

Sistema di
fissaggio
universale



PIANO LAMINATO

-80x80 (cm)

-70x70 (cm)

-90x90 (cm)



70x70 €45

80x80 €50

90x90 €55

PIANO LAMINATO BORDO ORO

-80x80 (cm)

-70x70 (cm)

-90x90 (cm)



CANNERO



ISPRA



VERBANIA



CANNOBIO

70x70 €78

80x80 €90

90x90 €105



Piani componibili

PIANO MANGO

Legno Mango 9483



-80x80 (cm)

Prezzo promo

€90

PIANO LEGNO

Legno naturale: 9292



-80x80 (cm)

- 70X70 (cm)

Prezzo promo

€78

PIANO TEAK

-80x80 (cm)



Teak:8033

Prezzo promo

€85



Basi componibili

DIAMOND SNACK

Base per tavolo componibile

Dimensioni: DIA62 h108

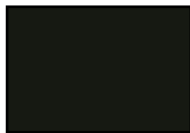

Nero: 7753

Prezzo promo

€68

Bianco:7821



H 108



Basi componibili

MOANA



Nero: 7760



Bianco: 7777

Prezzo promo
€65

Base in acciaio laccata nera o bianca.

Dimensioni: DIA50 H 75 (cm)

BASE ABBY



Bianco: 9711

Prezzo promo
€67

Base per tavolo componibile

Dimensioni: 49X49XH75 (cm)

BASE DIANA



Bianca: 7180

Prezzo promo
€54

Base per tavolo in ghisa 4 gambe a raggiera

Dimensioni: 56xh75 (cm)

BASE DALAN



Nero/oro: 7203

Prezzo promo
€85

Base in ghisa nera con dettagli oro.

Dimensioni: 40X H75 (cm)

BASE PIRAMIDE



Bianca: 1632

Prezzo promo
€62

Base per tavolo componibile in ghisa.

Dimensioni: 43X43xH 72

BASE MARIO



Bianca:0659

Prezzo promo

€50

Base per tavolo componibile

Dimensioni: 61x61x 75 (cm)

BASE GHISA



tortora:1553

Prezzo promo

€55

Base per tavolo componibile 4 razze

Dimensioni: Ø60 x 75 (cm)

BASE CLIFTON



Nero:1319

Base doppia in ghisa per tavolo componibile
Dimensioni: 40X75X72 (cm)

Prezzo promo

€123

BASE PIATTA



Tortora:1233

Antracite:1618

Basamento in acciaio – piede a piastra 40 x 40 cm – tubo acciaio
Dimensioni: 40X40H72

Prezzo promo

€55

Acero:6589

 Basi componibili

BASE ELISA

Base **PIEGHEVOLE** e **ACCATASTABILE, AUTOLIVELLANTE*** in **ALLUMINIO**, dal design a quattro gambe che si aprono a ventaglio. Questa base offre una buona stabilità al tavolo anche quando è aperto. Inoltre è dotato di un meccanismo di chiusura che permette di ripiegare il piano verso il basso e di riporre il tavolo in posizione verticale quando non è in uso e di un **gancio porta borse**.

Dimensioni: 67xh72

Prezzo promo

€78



© design registrato

 Tavoli autolivellanti

TAVOLI TETRIS

Tavolo in metallo verniciato a polvere nero, autolivellante, dal design minimal e geometrico. Si adatta a tutti gli ambienti.

Dimensioni:
80x60 h75 cm

Prezzo promo

€105 ordine
min 10 PZ



Bianco:1244
Nero:1245

Tavoli autolivellanti TAVOLI TETRIS

Tavolo in metallo verniciato a polvere nero,
autolivellante, dal design minimal e geometrico.
Si adatta a tutti gli ambienti.

Prezzo promo

€105 ordine
min 10 PZ

70x70

Bianco:1248



Grafite:1255



Nero:7870



Cuoio:1247



80x80

Bianco:1700



Grafite:1398



Nero:0829



Cuoio:1247



90x90

Bianco:1508



Nero: 1252

TAVOLI TETRIS

Tavolo in metallo verniciato a polvere nero, autolivellante, dal design minimal e geometrico. Si adatta a tutti gli ambienti.

Dimensioni:
150X80x h75 cm

Prezzo promo

€270 ordine
min 10 PZ

Marrone:1251



Bianco:1253





Tavoli autolivellanti

TAVOLI TETRIS

Tavolo da bar snack in metallo verniciato a polvere nero, autolivellante, dal design minimal e geometrico.

Si adatta a tutti gli ambienti.

Dimensioni:

60x60xh110cm

70x70xh110 cm

80x80xh110 cm

Prezzo promo

€155 ordine
min 10 PZ





Tavoli autolivellanti

TAVOLI TETRIS

Tavolo in metallo snack autolivellante

Dimensioni:
105X60XH110 (cm)

Prezzo promo

€185 ordine
min 10 PZ

Bianco:8990



Nero:1039



Grigio:7144



 Ourdoor

TAVOLINO TETRIS

Tavolo in metallo verniciato a polvere nero,
autolivellante, dal design minimal e geometrico.

Si adatta a tutti gli ambienti.

Dimensioni:
150X80X H30 cm

Prezzo promo

€270 ordine
min 10 PZ



UTILITY

Tavolo in metallo snack

Dimensioni:
105x60x110 (cm)

Prezzo promo

€95

Grigio:9652



Bianco: 9645





RIGLY

Tavolino 45 x 45 cm – polipropilene
con aggiunta di fibra di vetro – resi-
stente ai raggi uv

Prezzo promo

€32

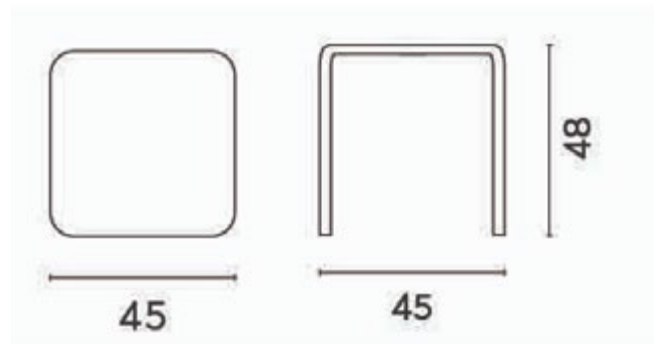

Antracite:1792



Bianco:1791



OUTDOOR *Collection*







LISBONA

Divano 2 posti con due poltrone in alluminio, cuscini sfoderabili inclusi

Dimensioni:

Divano: 156*89*82 cm

Poltrona: 82*86*82 cm

Tavolino: 130*73.5*38 cm

Prezzo promo

€952

Grigio antracite :8530



Grigio antracite : 5478



MALAGA

Divano 3 posti con due poltrone in alluminio, cuscini sfoderabili inclusi

Dimensioni:

Divano: 187*96.8*80 cm

Poltrona: 82*93.8*80 cm

Prezzo promo

€1008

Bianco:7618



© design registrato

SET TENERIFE

Set composto da due poltrone, un divano a 2 posti e un tavolino con piano in alluminio Ø80 cm – struttura in alluminio creta – corda per esterni sabbia – cuscini sfoderabili ecru'

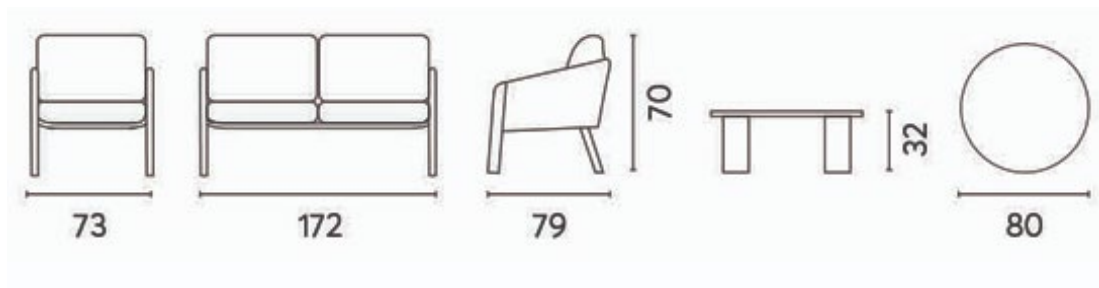

Prezzo promo

€1365



 Arredi Giardino

SET VENEZIA

Set composto da 2 poltrone, un divano 3 posti e un tavolino con piano in ceramic glass effetto cemento 110 X 60 X 40 cm - struttura in alluminio bianco - corda e cuscini sfoderabili grigio chiaro.

Prezzo promo

€1165

Struttura bianca/corda grigia:1685



 Arredi Giardino

KINOS

Set composto da 2 poltrone, 1 divano due posti e un tavolino con piano in ceramica, cuscini ecrù, struttura in ferro e braccioli effetto legno

Prezzo promo

€358



rosso:8019



MARATEA

Set TARQUINIA – composto da 2 poltrone,
1 divano e 1 tavolino con piano in ceramic
glass ø 65 cm x 41 cm – textilene antracite
e struttura in ferro

Prezzo promo

€212



Antracite:6734



Salvia:1549





Bianco : 8929

 Arredi Giardino
CORFÙ

Set in polipropilene dallo stile moderno e contemporaneo, composto da divano due posti, due poltrone e un tavolino.

Dimensioni:

poltrona 84x77x69xhs 35cm

divano: 150x77x69xhs 35

tavolino: 150x77x69xhs35

Prezzo promo

€358

Prezzo promo

€225

ordine
min 8 set (6 bianchi,
2 senape).
+ 2 in omaggio

IMPILABILE

Ambra:8899



 Arredi Giardino

SET NAPOLI

Set composto da 2 poltrone, un divano tre posti e un tavolino in legno di acacia con cuscini in tessuto bianchi.

Prezzo promo

€1512

Ecrù: ART01684



 Arredi Giardino

SET SICILIA

Set composto da 2 poltrone, un divano tre posti e un tavolino 120 x 65 x 32 cm - struttura in legno di acacia - corda antracite - con cuscini sfoderabili grigi

Prezzo promo

€1322

Acacia/ grigio: 1682



TARANTO

Set composto da 2 poltrone, un divano a 2 posti e un tavolino 110 x 65 x 40 cm, realizzato in rattan naturale. Cuscini in policotone ecrù sfoderabili.

Prezzo promo

€2128

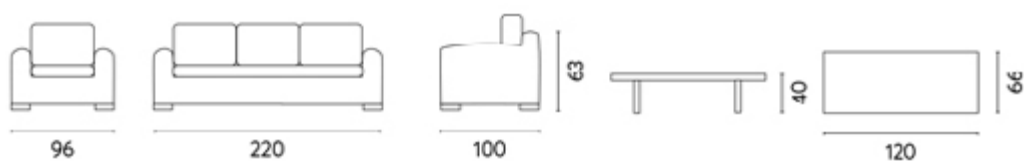

Rattan:0648



 Arredi Giardino

SET AVELLINO

Set composto da 2 poltrone, un divano due posti e un tavolino teak con cuscini in tessuto panna.

Prezzo promo

€1199

Teak:1685





Antracite:1547



EMPEDOCLE

Tavolo rettangolare allungabile in alluminio con doghe, verniciato a polvere epossidica. Perfetto per arredare ambienti interni ed esterni.

P. Ercole ospita dalle 10 / 12 persone.

Dimensioni: 200/300X102 cm

Prezzo promo

€728

bianco: 1548

3 m



CORDOBA

Tavolo rettangolare allungabile in alluminio con doghe, verniciato a polvere epossidica.

Perfetto per arredare ambienti interni ed esterni.

Cordoba ospita dalle 4/6 persone.

Dimensioni: 82*163 x L. 90 x H 75 cm

Prezzo promo

€207



Grigio: 0361



Bianco:0316

JEFF

Tavolo in alluminio allungabile, allunghe con gambe scorrevoli, piano in alluminio

Dimensioni: 100/150 x 150 cm

Prezzo promo

€660

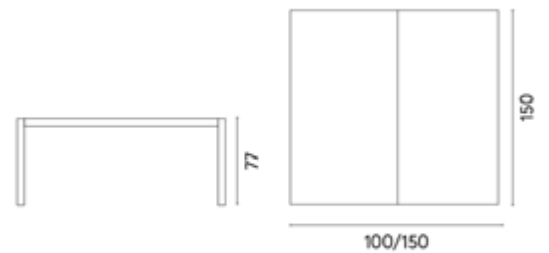

Antracite:6277





Antracite:1783

MYKONOS

Tavolo rettangolare allungabile in alluminio con doghe, verniciato a polvere epossidica.

Perfetto per arredare ambienti interni ed esterni.

P. Ercole ospita dalle 10 / 14 persone.

Dimensioni: 265/330/398*110

Prezzo promo

€952

Bianco:1686

4 m



 Arredi Giardino

SUTRA

Tavolo in teak allungabile
Dimensioni 180/250*100

Prezzo promo

€778

Teak:1689



LIPSIA

Tavolo in teak ovale
Dimensioni: 120/170*120

Prezzo promo

€403

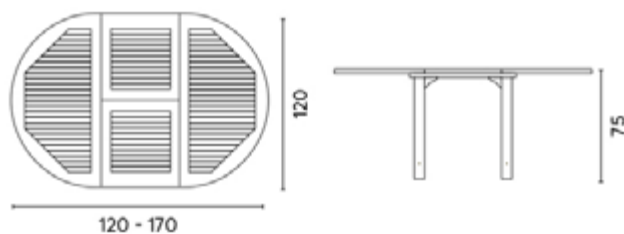

Teak: 1700

TAVOLO GIACA

Tavolo in teak rettangolare
Dimensioni: 250X100

Prezzo promo

€728



Teak:1690



TAVOLO SIRI

Tavolo ovale allungabile in teak

Dimensioni:
180/240*120

Prezzo promo

€448

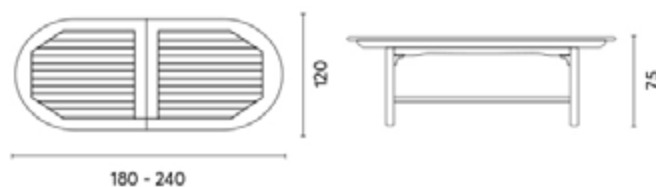

Teak:1697



 Arredi Giardino

SIRI

Sedia in teak pieghevole con cuscino ecru

Prezzo promo

€64

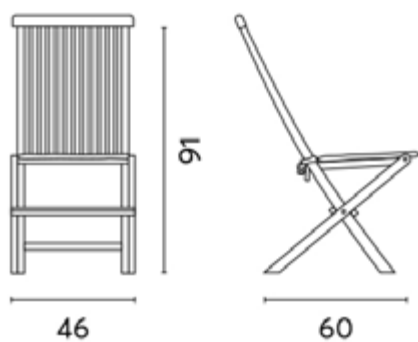

Teak/ cuscino ecru: 1698



 Arredi Giardino

BANCONE BAR

Bancone bar in teak rettangolare con
poggia piedi

Dimensioni: 250x75x107 cm

Prezzo promo

€627

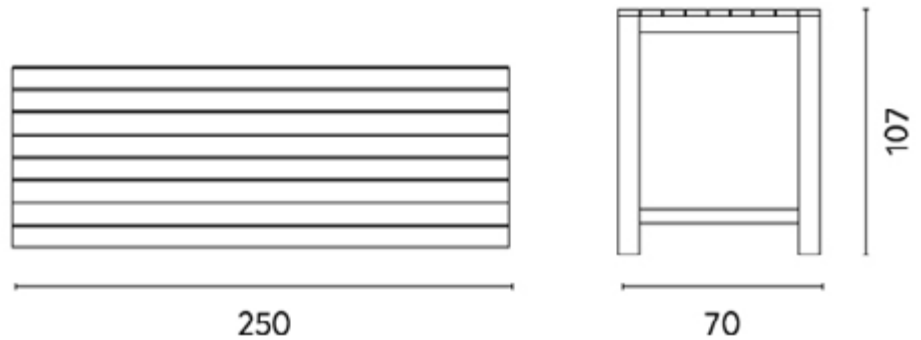

Teak:1691





PORTABICCHIERE

- ✓ Integrato nel piano
- ✓ Struttura stabile e discreta
- ✓ Ideale per ambienti outdoor e contract

PORTA TELEFONO

- ✓ Alloggiamento ergonomico
- ✓ Accesso immediato al dispositivo
- ✓ Perfetto per momenti di relax

LETTINO DUBAI

Lettino prendisole monoblocco, dal design scultoreo e fluido, con linee continue e sinuose.

La struttura è in materiale plastico stampato (look resina), finito bianco opaco/lucido, con superficie liscia e pulita.

La seduta è ergonomica, con profilo ondulato che accompagna il corpo: zona gambe allungata, seduta centrale incavata e schienale integrato leggermente rialzato.

Base piena e stabile, senza braccioli, senza cuscini, stile minimale e contemporaneo.

Dimensioni:
183*83.5*71

Prezzo promo

€200 ordine
min 20 PZ su pedana

Bianco:9832



© design registrato



LETTINO TAO

struttura in alluminio creta e
textilene sabbia – cuscino beige
idrorepellente

Prezzo promo

€290

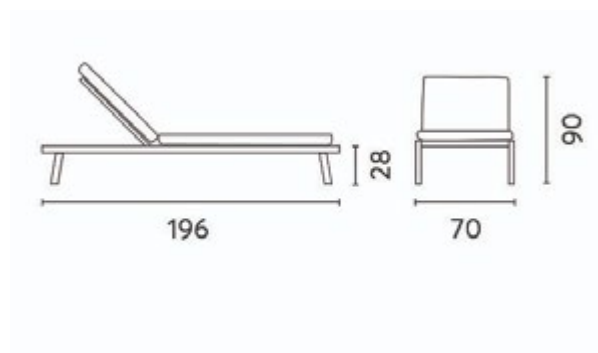

Creta\sabbia:1787





Bianco:9058

BARCELLONA

Letto da esterno con struttura in alluminio verniciato a polvere, seduta e schienale in textilene imbottito.

Dimensioni:
B 190 x P 70 x H 30

Prezzo promo

€163

Grigio\bianco: 1701



Tortora\bianco: 9065



LETTINO SIESTA

Lettino da spiaggia in legno mango.

Prezzo promo

€207

Legno:8233



LETTINO NAPOLI

Lettino in legno di acacia con
finitura in color TEAK - con cuscino
sfoderabili sabbia

Prezzo promo

€277

Acacia/bianco:1883



SDRAIO MARE

Sdraio mare pieghevole con struttura
in alluminio con textilene e cuscino

Dimensioni:
tubo 35x18 mm

Prezzo promo

€47

Tortora:1556



Grigio:1555



Grigio:1290



KONA

Il dondolo ha una forma a goccia/ovale, con una struttura intrecciata che crea un effetto leggero e arioso. La seduta è ampia e avvolgente, progettata per offrire comfort, ed è completata da cuscini morbidi e imbottiti che riempiono l'interno.

È sospeso tramite un gancio e una catena collegati a una struttura curva con base circolare, che permette al dondolo di oscillare liberamente. Il design combina linee morbide e moderne con un intreccio decorativo che rende il pezzo elegante e adatto a spazi relax sia interni che esterni.

Dimensioni:

base: Diam108xH198 seduta104x73xH117

Prezzo promo

€218



Beige:4321



Arredi da giardino

DAYBED

lettino 205 x 186 x h. 200 cm - schienale doppio reclinabile -
cuscini in PVC grigio chiaro - struttura alluminio BIANCO 80
x 80 mm - tende in poliestere 180 gr. grigio chiaro - tetto in
textilene bianco

Prezzo promo

€1175



 Arredi da giardino

PERGOLA

Pergola con struttura alluminio e tetto scorrevole
3x3

Prezzo promo

€269



bianco: 0876 - 1 pz

 Arredi da giardino

PERGOLA

Pergola con struttura alluminio (3*4) 4 pilastri
tetto lamellare orientabile tramite manovella – altezza max. 2,50 mt – sistema di
scarico
dell'acqua integrato all'interno dei pali portanti

Prezzo promo

€1657



 Arredi da giardino

PERGOLA

Pergola con struttura alluminio (3*6) 6 pilastri

Prezzo promo

€2217

bianco: 1695





 Arredi da giardino

OMBRELLONE MACRAME' ROTONDO

Ombrellone macrame' Ø 2,5 mt. – fusto legno Ø 48/8 – doppia carrucola – bacchette
17 X 35 mm – altezza max. con base 2,64 mt – copertura rete e frangia

Prezzo promo

€235

H max 2,64 m

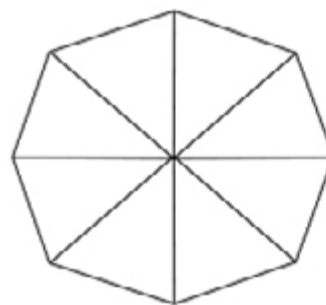

250

Corda:1786



OMBRELLONE AROMA

3*3
BIANCO

Prezzo promo

€482

3*4
BIANCO
O GRIGIO

Prezzo promo

€705

Caratteristiche tecniche:

- Telo 3x3 m in tessuto da 250g in poliestere (trattato in PA).
- Palo centrale in alluminio misura: 93x57 mm
- 8 solide stecche della misura di 28x18 mm
- Sistema di apertura retrattile che permette la chiusura parallela al palo.
- Maniglia per spostamento agevolato del telo e inclinazione in 4 posizioni
- Il palo girevole con pedale permette all'ombrellone di ruotare di 360°
- Camino antivento per una maggiore stabilità.
- Cover copri telo inclusa

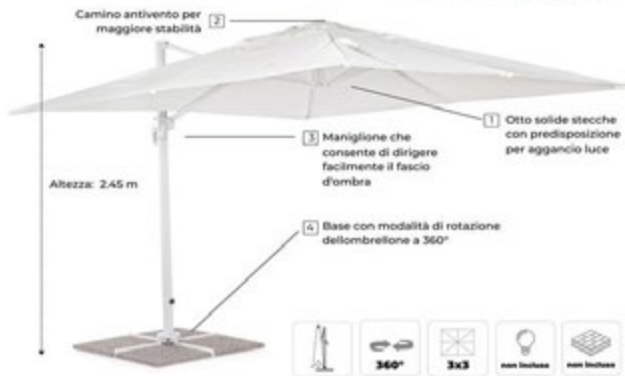

 Arredi da giardino

OMBRELLONE DOPPIO

Ombrellone doppio p.laterale antracite con telo ecrù
3*3H2.60 3*3H2.60

Prezzo promo

€850





CRIBEL S.r.l. a socio unico
Via per Grottaglie, km 1.800 z.i.
72021 Francavilla Fontana (BR) - ITALY
tel. +39 0831 821040

www.cribel.it
www.ordini@cribel.it